



# TPU BELTS<sup>®</sup>

---

CATALOG NO. 20166

EDITION 2022

SUPERSEDES 20166 (2014)

## **THERMOPLASTIC POLYURETHANE BELT PROGRAM**

**PRODUCT AND TECHNICAL INFORMATION**







# INDEX

<b>INTRODUCTION</b> .....	<b>2</b>
POLYURETHANE BELTS .....	3
TOOTH PROFILES .....	4
MATERIALS .....	6
GATES TPU PRODUCTS .....	7
<b>SYNCHRO-POWER LINEAR</b> .....	<b>8</b>
T PITCHES .....	9
AT PITCHES .....	13
HTD PITCHES .....	19
HPL PITCHES .....	24
STD PITCHES .....	27
GPP PITCHES .....	29
IMPERIAL PITCHES .....	33
E-BELT .....	37
WR-WATER RESISTANT BELTS .....	38
SYNCHRO-CLEAN .....	43
SELF-TRACKING BELTS .....	44
<b>SYNCHRO-POWER FLAT</b> .....	<b>58</b>
<b>SYNCHRO-POWER WIDE</b> .....	<b>64</b>
GMT3 .....	65
T PITCHES .....	66
HTD PITCHES .....	68
IMPERIAL PITCHES .....	69
CC8 .....	70
<b>MECHANICAL FABRICATION PROCESS</b> .....	<b>71</b>
<b>SYNCHRO-POWER SLEEVE</b> .....	<b>72</b>
<b>SYNCHRO-POWER FLEX</b> .....	<b>80</b>
T PITCHES .....	81
AT PITCHES .....	84
HTD PITCHES .....	90
IMPERIAL PITCHES .....	94
<b>ENDLESS WELDED OR TRULY ENDLESS?</b> .....	<b>95</b>
<b>BACKINGS</b> .....	<b>96</b>
<b>PROFILE BELTS</b> .....	<b>102</b>
<b>FABRICATION CAPABILITIES</b> .....	<b>108</b>
<b>TECHNICAL DESIGN</b> .....	<b>110</b>
<b>SONIC TENSION METER</b> .....	<b>127</b>



# INTRODUCTION

## OUR EXPERTISE

Gates TPU brings a world-class combination of expert knowledge, global coverage, and superior service to exceed our customers' expectations. Backed by 100 years of Gates innovation and industry leading product performance and quality, we offer the most compelling thermoplastic polyurethane belt portfolio in the market.

Our products are used in various industries including material handling, intralogistics, general automation, and food processing.



### KNOWLEDGE

#### APPLICATION KNOW-HOW

Our technical experts will work with your team to deliver a solution that meets your application need.

#### EXPERTISE

Our dedicated team can answer questions, provide training and information, and solve challenges.



### PRODUCT

#### QUALITY

Our products deliver the performance and reliability that customers expect from Gates around the world. We guaranty the highest quality, meeting & exceeding the standards of ISO 9001, ISO 14001 and ISO 50001.

#### OFFERING

We offer a full TPU belt portfolio for all positioning, conveyance, and lifting applications.



### EXPERIENCE

#### RESPONSIVENESS

Our regional teams are flexible, close to the market, and able to provide hands on service at customer sites.

#### DELIVERY

With a global production and distribution footprint, including distribution partners worldwide, Gates offers global service to solve your challenges. Exceptional on time delivery performance and short lead times set the standard in the industry.



### SUSTAINABILITY

#### HUMAN HEALTH

Gates products comply with the requirements laid down in the REACH (Registration, Evaluation, Authorization of Chemical Substances) regulation. All substances in our belts requiring registration will be duly registered in the central database run by the European Chemicals Agency (ECHA).

#### ENVIRONMENT

Gates products help preserving our planet by saving energy, less environmental impact, less noise pollution, less waste.





# POLYURETHANE BELTS

**OUR PRODUCT QUALITY IS REVEALED IN THE DETAILS. — NARROW TOLERANCES AND PERFECT TOOTH ENGAGEMENT ARE GUARANTEED.**

Gates TPU Polyurethane Timing Belts are made from high quality, abrasion-resistant polyurethane in combination with high strength steel or aramid cords. Nearly every extruded belt type can be additionally customized by special machining or the addition of various coatings or profiles.

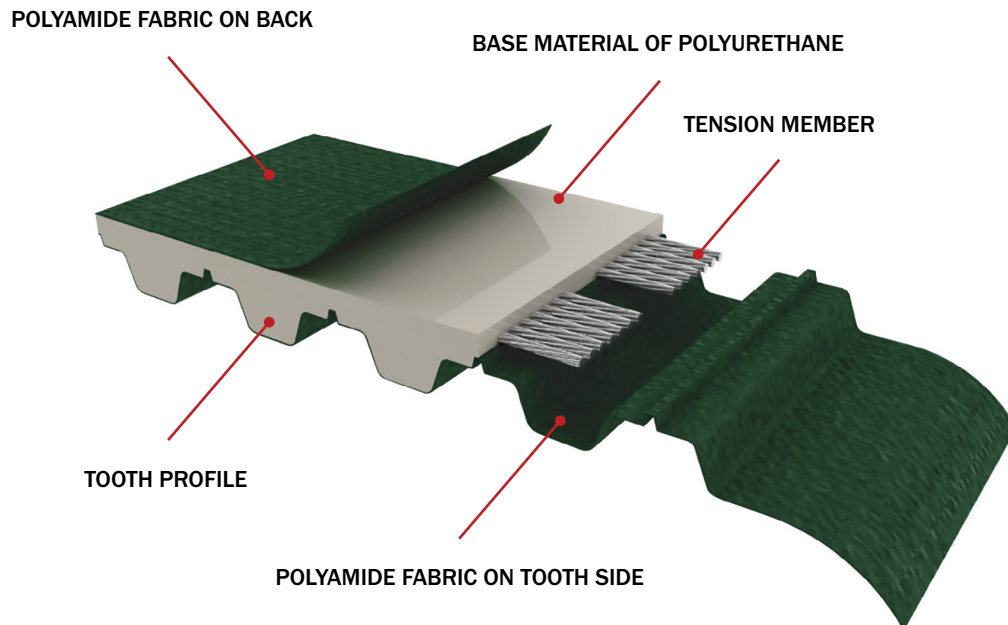

## ATTRIBUTES

- Low-maintenance polyurethane construction
- High tensile strength
- Abrasion and UV resistant
- Low pre-tension
- Excellent durability vs. moisture
- Various cord and Polyurethane grades available

## CHEMICAL ATTRIBUTES

- Long-lasting
- High chemical resistance
- High durability vs. detergent
- Excellent durability vs. oil and fat
- Conditionally permanent vs. acids and bases





# TOOTH PROFILES

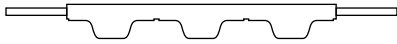

## IMPERIAL TOOTH PROFILE

PITCH: XL / L / H / XH

According to DIN ISO 5296

Attributes: Low tooth profiles with large surface area

Applications:

- Low to medium load conveying



## T TOOTH PROFILE

PITCH: T2.5 / T5 / T10 / T20

According to ISO 17396

Attributes: Developed to enable higher load carrying capacity combined with lower backlash

Applications:

- Low to medium load conveying



## AT TOOTH PROFILE

PITCH: AT5 / AT10 / AT20

According to ISO 17396

Attributes: Stronger cords and higher tooth shear strength for improved performance

Applications:

- Linear positioning
- Power transmission
- Medium to high load conveying

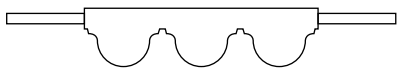

## HTD TOOTH PROFILE

PITCH: HTD5 / HTD8 / HTD14

According to ISO 13050

Attributes: Higher tooth meshing, equal tension distribution and load transmission

Reduced wear and noise characteristics

Applications:

- Linear / rotary positioning
- Power transmission



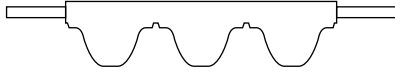

## HPL TOOTH PROFILE

PITCH: HPL3, HPL5 and HPL8  
 Attributes: High-performance synchronous belt  
 Gates GT™ tooth shape

Applications:

- Linear positioning
- Lifting

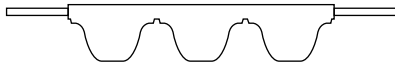

## STD TOOTH PROFILE

PITCH: STD5 / STD8  
 According to ISO 13050  
 Attributes: Reduced wear and noise characteristics

Applications:

- Linear positioning
- Power transmission

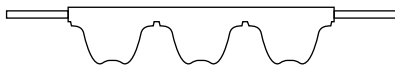

## GPP TOOTH PROFILE

PITCH: GPP8 / GPP14  
 According to ISO 13050  
 Attributes: Reduced wear and noise characteristics

Applications:

- Linear positioning
- Lifting

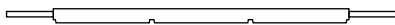

## FLAT BELTS

PITCH: F20 / F30 / F48  
 Attributes: Easy belt guiding  
 Small pulley diameters

Applications:

- Lifting
- Pulling



## WIDE BELTS

PITCH: WT5 / WT10 / WH / GMT3TM / WHTD8M  
 Attributes: Standard width 200mm for WT5 and 450mm or  
 18" for all other wide belts  
 Alternative to plastic modular chains and flat  
 belting

Applications:

- Synchronous conveying
- Hygienic Industry
- Tire Industry
- Food industry applications





# MATERIALS

## POLYURETHANE GRADES

TPU RESIN	BELT TYPES	HARDNESS	TEMP RANGE
<b>TPU RESINS FOR STANDARD APPLICATIONS</b>			
R1	Linear, Flat & Wide Belt	92° Shore A	-5 to +70°C
R2	Linear, Flat & Wide Belt	85° Shore A	-10 to +60°C
R3	Sleeves	84° Shore A	-25 to +75°C
R23	Flex Belt	90° Shore A	-5 to +70°C
<b>TPU RESINS FOR LOW TEMPERATURE APPLICATIONS</b>			
R23T	Linear, Flat & Flex Belt	90° Shore A	-30 to +60°C
<b>TPU RESINS FOR FOOD CONTACT *</b>			
FDA	Linear & Wide Belt	85° Shore A	-10 to +60°C

\* Please contact our application engineers for available belt constructions that meet USDA or EU food regulations.

## CORD CONSTRUCTIONS

DESIGNATOR	DESCRIPTION
BSL	Basic steel
SL	Steel
HF	High Flexible Steel
RSL	Reinforced Steel
RHF	Reinforced High Flexible Steel
NIRO	Stainless Steel
KV	Aramid
RKV	Reinforced Aramid

## POLYAMID FABRIC OPTIONS

NT	Polyamid fabric on tooth side
NB	Polyamid fabric on back
NTB	Polyamid fabric on tooth and back
AS	Antistatic Polyamid fabric on tooth and back



# GATES TPU PRODUCTS

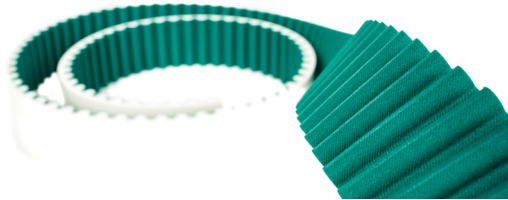

## SYNCHRO-POWER LINEAR

Open ended or endless welded TPU timing belt for linear movement and conveying.

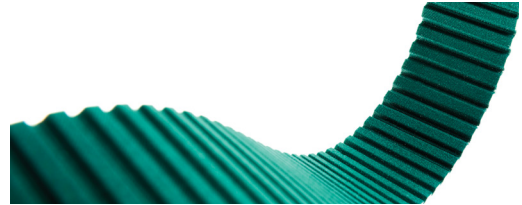

## SYNCHRO-POWER FLEX

Truly endless TPU timing belt up to 22,9m for power transmission and rotary positioning.



## SYNCHRO-POWER FLAT

Open ended TPU flat belt for pulling and lifting applications.



## BELTS WITH BACKINGS

Endless welded TPU timing belt for conveying and transportation.

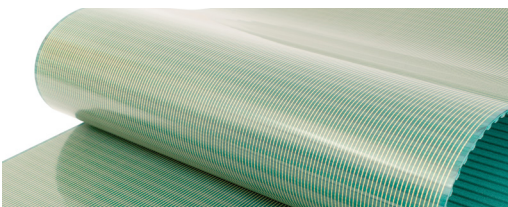

## SYNCHRO-POWER WIDE

Endless welded wide TPU timing belt for synchronous conveying.

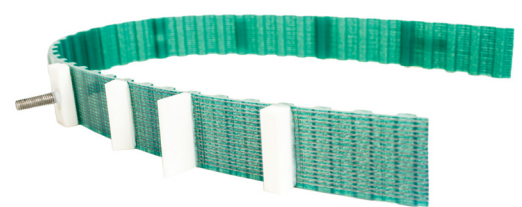

## BELT WITH PROFILES

Endless welded TPU timing belt for conveying and transportation.



## SYNCHRO-POWER SLEEVES

Truly endless timing belt for light power transmission and rotary positioning.

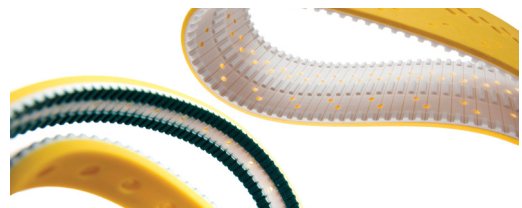

## FABRICATED BELTS

Endless welded TPU timing belt for conveying and transportation.



# SYNCHRO-POWER LINEAR

## TIMING BELTS

Gates TPU linear timing belts are manufactured in standard roll lengths in different pitches, constructions and tooth shapes. The wide range of various designs offers the exact solution for nearly every application. Linear belts are available as roll stock, open ended (long length), pre-punched or endless, thermal welded belts.

For special custom applications, the belts can be coated with various backings and/or manufactured with welded on profiles.

**GATES TPU LINEAR BELTS ARE DESIGNED TO ENSURE HIGH GRADE PERFORMANCE FOR BOTH, POWER TRANSMISSION AND LINEAR APPLICATIONS AND CAN BE USED FOR A BROAD RANGE OF DEMANDS, SPEEDS, AND APPLICATIONS.**

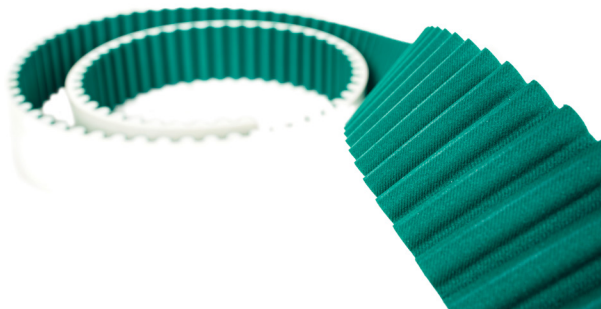

### ATTRIBUTES

- Thermoplastic polyurethane construction
- High tensile strength and stiffness
- Parallel cord construction for uniform tensioning
- Smooth, low-noise operation
- Temperature range:  
Standard TPU: R1 - 5° to + 70° C  
Low temp TPU: R23T - 30° to + 50° C
- Extended service temperature range is available on request
- FDA and EU food approval for various pitches

### APPLICATIONS

- Conveying- and handling equipment
- Linear applications
- Vertical Lifting
- Synchronous conveying applications
- Automatic assembly machines
- Door drives
- Textile industry

### PROCESSING OPTIONS

- Backings - Further information on page 96
- Profiles - Further information on page 102
- Special processing - Further information on page 108



**T5 / PITCH: 5MM**

**PRODUCT SPECIFICATIONS**

<b>PITCH</b>	5 mm
<b>STANDARD THICKNESS</b>	2,2 mm
<b>WIDTH TOLERANCE</b>	
< 50MM WIDTH	+0,5 mm
> 50MM WIDTH	+0,75 mm
<b>MINIMUM WELDED BELT LENGTH</b>	480 mm
<b>STANDARD ROLL LENGTH (TOLERANCE ±1%)</b>	100 m
<b>STANDARD COLOR</b>	White
<b>FDA/EU APPROVAL</b>	Optional
<b>POLYAMIDE FABRIC</b>	Optional NT, NB & NTB

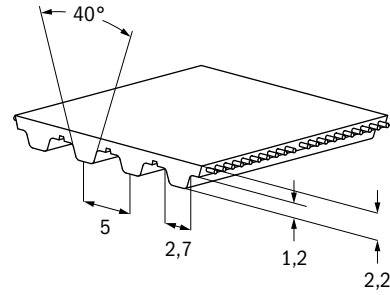

**MIN PULLEY DIAMETER:**

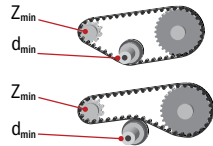

	STEEL	ARAMID
<b>z min</b>	10	10
<b>d min</b>	30	30
<b>z min</b>	15	15
<b>d min</b>	30	30

**dmin** = 50mm for low temperature applications

POLYURETHANE	HARDNESS [° SHORE A]	TEMPERATURE RANGE [° C]	FEATURE
R1	92	-5 to +70	Standard
R2	85	-10 to +60	
R23T	90	-30 to +50	Low Temperature
FDA	85	-10 to +60	With Aramid Cord Only

**TECHNICAL DATA**

STANDARD WIDTH (MM)	UNIT	10	16	25	32	50	75	100
<b>BREAKING FORCE / AVERAGE VALUE</b>								
Steel	[N]	1.250	2.000	3.375	4.250	6.875	10.375	13.875
Aramid	[N]	3.162	5.245	8.370	10.800	17.050	25.730	34.410
<b>ALLOWABLE BELT FORCE / OPEN ENDED</b>								
Steel	[N]	311	498	840	1.058	1.711	2.582	3.453
Aramid	[N]	346	574	916	1.181	1.865	2.814	3.764
<b>ALLOWABLE BELT FORCE / ENDLESS WELDED</b>								
Steel	[N]	156	249	420	529	856	1.291	1.727
Aramid	[N]	259	430	687	886	1.399	2.111	2.823
<b>ALLOWABLE EFFECTIVE FORCE / MINIMUM 12 TEETH IN MESH</b>								
	[N]	250	400	625	800	1.250	1.875	2.500
<b>BELT WEIGHT</b>								
Steel	[kg/m]	0,02	0,04	0,06	0,07	0,11	0,16	0,22
Aramid	[kg/m]	0,02	0,03	0,05	0,06	0,10	0,15	0,20
<b>SPECIFIC BELT STIFFNESS</b>								
Steel	[N]	77.778	124.444	210.000	264.444	427.778	645.556	863.333
Aramid	[N]	86.464	143.428	228.875	295.334	466.227	703.579	940.931

**T5-AS / PITCH: 5MM**

**PRODUCT SPECIFICATIONS**

<b>PITCH</b>	5 mm
<b>STANDARD THICKNESS</b>	2,6 mm
<b>WIDTH TOLERANCE</b>	
< 50MM WIDTH	+,-0,5 mm
> 50MM WIDTH	+,-0,75 mm
<b>MINIMUM WELDED BELT LENGTH</b>	480 mm
<b>STANDARD ROLL LENGTH (TOLERANCE ±1%)</b>	100 m
<b>STANDARD COLOR</b>	Black
<b>FDA/EU APPROVAL</b>	No
<b>POLYURETHANE</b>	92 Shore A
<b>POLYAMIDE FABRIC</b>	Antistatic fabric on tooth and back
<b>MEET ANTISTATIC STANDARD</b>	IES DTS 60079-32 TRBS 2153 CENELEC TR50404

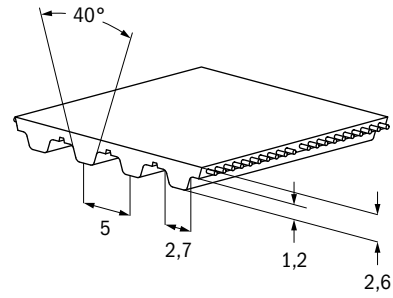

**MIN PULLEY DIAMETER:**

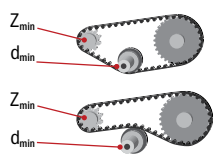

	STEEL
<b>z min</b>	10
<b>d min</b>	30
<b>z min</b>	15
<b>d min</b>	30

POLYURETHANE	HARDNESS [°SHORE A]	TEMPERATURE RANGE [°C]	FEATURE
R1	92	-5 to +70	Standard

**TECHNICAL DATA**

STANDARD WIDTH (MM)	UNIT	10	16	25	32	50	75	100
<b>BREAKING FORCE / AVERAGE VALUE</b>								
Steel	[N]	1.250	2.000	3.375	4.250	6.875	10.375	13.875
<b>ALLOWABLE BELT FORCE / OPEN ENDED</b>								
Steel	[N]	311	498	840	1.058	1.711	2.582	3.453
<b>ALLOWABLE BELT FORCE / ENDLESS WELDED</b>								
Steel	[N]	156	249	420	529	856	1.291	1.727
<b>ALLOWABLE EFFECTIVE FORCE / MINIMUM 12 TEETH IN MESH</b>								
	[N]	250	400	625	800	1.250	1.875	2.500
<b>BELT WEIGHT</b>								
Steel	[kg/m]	0,02	0,04	0,05	0,07	0,11	0,17	0,22
<b>SPECIFIC BELT STIFFNESS</b>								
Steel	[N]	77.778	124.444	210.000	264.444	427.778	645.556	863.333

**T10 / PITCH: 10MM****PRODUCT SPECIFICATIONS**

<b>PITCH</b>	10 mm
<b>STANDARD THICKNESS</b>	
T10	4,5 mm
T10HB	6,5 mm
<b>WIDTH TOLERANCE</b>	
< 50MM WIDTH	+,-0,5 mm
> 50MM WIDTH	+,-0,75 mm
<b>MINIMUM WELDED BELT LENGTH</b>	
< 100MM WIDTH	480 mm
> 100MM WIDTH	960 mm
<b>STANDARD ROLL LENGTH (TOLERANCE ±1%)</b>	100 m
<b>STANDARD COLOR</b>	White
<b>FDA/EU APPROVAL</b>	Option
<b>POLYAMIDE FABRIC</b>	Optional NT, NB & NTB
<b>ANTISTATIC NYLON</b>	Optional

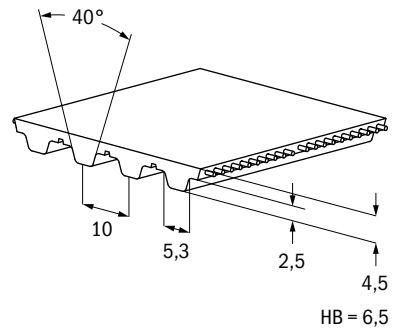
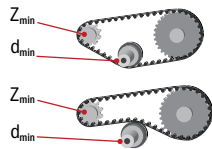
**MIN PULLEY DIAMETER:**

	STEEL	ARAMID	STEEL HF
<b>z min</b>	14	14	12
<b>d min</b>	45	45	38
<b>z min</b>	20	20	15
<b>d min</b>	80	80	60

POLYURETHANE	HARDNESS [ ' SHORE A ]	TEMPERATURE RANGE [ ' C ]	FEATURE
R1	92	-5 to +70	Standard
R2	85	-10 to +60	
R23T	90	-30 to +50	Low Temperature
FDA	85	-10 to +60	With Aramid Cord Only

**TECHNICAL DATA**

STANDARD WIDTH (MM)	UNIT	12	16	25	32	50	75	100	150
<b>BREAKING FORCE / AVERAGE VALUE</b>									
Steel	[N]	2.940	4.200	7.140	9.240	14.700	22.260	29.820	44.940
Aramid	[N]	3.601	4.980	8.085	10.500	16.709	25.333	33.957	51.205
Steel HF	[N]	4.340	6.200	10.540	13.640	21.700	32.860	44.020	66.340
<b>ALLOWABLE BELT FORCE / OPEN ENDED</b>									
Steel	[N]	786	1.123	1.909	2.470	3.929	5.950	7.971	12.012
Aramid	[N]	474	655	1.064	1.381	2.198	3.332	4.467	6.736
Steel HF	[N]	964	1.376	2.340	3.028	4.818	7.295	9.773	14.728
<b>ALLOWABLE BELT FORCE / ENDLESS WELDED</b>									
Steel	[N]	393	561	954	1.235	1.965	2.975	3.985	6.006
Aramid	[N]	355	491	798	1.036	1.648	2.499	3.350	5.052
Steel HF	[N]	482	688	1.170	1.514	2.409	3.648	4.886	7.364
<b>ALLOWABLE EFFECTIVE FORCE / MINIMUM 12 TEETH IN MESH</b>									
	[N]	683	910	1.423	1.821	2.845	4.268	5.690	8.535
<b>BELT WEIGHT</b>									
Steel	[kg/m]	0,05	0,07	0,11	0,14	0,22	0,33	0,44	0,66
Aramid	[kg/m]	0,04	0,06	0,09	0,12	0,18	0,27	0,36	0,54
Steel HF	[kg/m]	0,06	0,08	0,12	0,15	0,24	0,35	0,47	0,71
HB Steel	[kg/m]	0,08	0,11	0,17	0,21	0,34	0,50	0,67	1,01
HB Aramid	[kg/m]	0,07	0,10	0,15	0,19	0,30	0,44	0,59	0,89
HB Steel HF	[kg/m]	0,09	0,12	0,18	0,22	0,36	0,52	0,70	1,06
<b>SPECIFIC BELT STIFFNESS</b>									
Steel	[N]	196.463	280.662	477.125	617.456	982.316	1.487.507	1.992.699	3.003.081
Aramid	[N]	118.403	163.779	265.875	345.283	549.475	833.075	1.116.675	1.683.875
Steel HF	[N]	240.882	344.118	585.000	757.059	1.204.412	1.823.824	3.443.235	5.182.059



**T20 / PITCH: 20MM**

**PRODUCT SPECIFICATIONS**

<b>PITCH</b>	20 mm
<b>STANDARD THICKNESS</b>	8,0 mm
<b>WIDTH TOLERANCE</b>	+ -1,0 mm
<b>MINIMUM WELDED BELT LENGTH</b>	1000 mm
<b>STANDARD ROLL LENGTH (TOLERANCE ±1%)</b>	50 m
<b>STANDARD COLOR</b>	White
<b>FDA/EU APPROVAL</b>	Option
<b>POLYAMIDE FABRIC</b>	Optional NT, NB & NTB

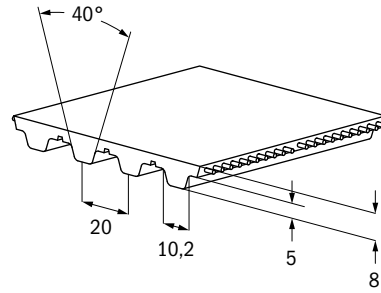

**MIN PULLEY DIAMETER:**

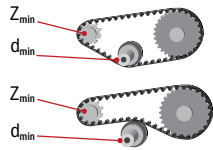

	STEEL	ARAMID	STEEL HF	STAINLESS STEEL
<b>z min</b>	15	15	12	20
<b>d min</b>	120	120	110	130
<b>z min</b>	25	25	21	30
<b>d min</b>	120	120	120	180

POLYURETHANE	HARDNESS [° SHORE A]	TEMPERATURE RANGE [° C]	FEATURE
R1	92	-5 to +70	Standard
R2	85	-10 to +60	
R23T	90	-30 to +50	Low Temperature
FDA	85	-10 to +60	With Aramid Cord Only

**TECHNICAL DATA**

STANDARD WIDTH (MM)	UNIT	25	32	50	75	100	150
<b>BREAKING FORCE / AVERAGE VALUE</b>							
Steel	[N]	14.250	18.050	29.450	44.650	59.850	90.250
Aramid	[N]	16.185	21.019	33.449	50.713	67.977	102.505
Steel HF	[N]	12.975	16.435	26.815	40.655	54.495	82.175
Stainless Steel	[N]	10.688	13.538	22.088	33.488	44.888	67.688
<b>ALLOWABLE BELT FORCE / OPEN ENDED</b>							
Steel	[N]	3.741	4.739	7.731	11.722	15.712	23.693
Aramid	[N]	1.675	2.175	3.461	5.247	7.033	10.606
Steel HF	[N]	3.456	4.378	7.142	10.829	14.515	21.888
Stainless Steel	[N]	2.806	3.554	5.799	8.791	11.784	17.770
<b>ALLOWABLE BELT FORCE / ENDLESS WELDED</b>							
Steel	[N]	1.871	2.369	3.866	5.861	7.856	11.847
Aramid	[N]	1.256	1.631	2.596	3.935	5.275	7.954
Steel HF	[N]	1.728	2.189	3.571	5.414	7.258	10.944
Stainless Steel	[N]	1.403	1.777	2.899	4.396	5.892	8.885
<b>ALLOWABLE EFFECTIVE FORCE / MINIMUM 12 TEETH IN MESH</b>							
	[N]	3.075	3.936	6.150	9.225	12.300	18.450
<b>BELT WEIGHT</b>							
Steel	[kg/m]	0,19	0,24	0,37	0,56	0,75	1,12
Aramid	[kg/m]	0,18	0,23	0,36	0,54	0,72	1,08
Steel HF	[kg/m]	0,15	0,19	0,30	0,44	0,59	0,89
Stainless Steel	[kg/m]	0,19	0,24	0,37	0,56	0,74	1,11
<b>SPECIFIC BELT STIFFNESS</b>							
Steel	[N]	935.250	1.184.650	1.932.850	2.930.450	3.928.050	5.923.250
Aramid	[N]	418.650	543.687	865.210	1.311.770	1.758.330	2.651.450
Steel HF	[N]	864.000	1.094.400	1.785.600	2.707.200	3.628.800	5.472.000
Stainless Steel	[N]	701.438	888.488	1.449.638	2.197.838	2.946.038	4.442.438

# AT5 / PITCH: 5MM

### PRODUCT SPECIFICATIONS

<b>PITCH</b>	5 mm
<b>STANDARD THICKNESS</b>	2,7 mm
<b>WIDTH TOLERANCE</b>	
< 50MM WIDTH	+0,5 mm
> 50MM WIDTH	+0,75 mm
<b>MINIMUM WELDED BELT LENGTH</b>	480 mm
<b>STANDARD ROLL LENGTH (TOLERANCE ±1%)</b>	100 m
<b>STANDARD COLOR</b>	White
<b>FDA/EU APPROVAL</b>	Option
<b>POLYAMIDE FABRIC</b>	Optional NT, NB & NTB

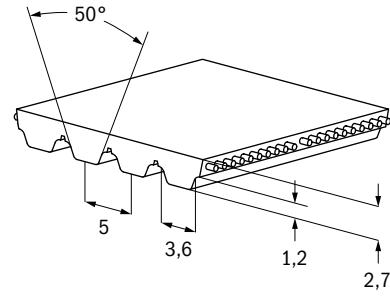

### MIN PULLEY DIAMETER:

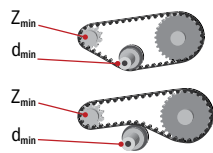

	STEEL	ARAMID
<b>z min</b>	18	18
<b>d min</b>	29	29
<b>z min</b>	25	25
<b>d min</b>	60	60

POLYURETHANE	HARDNESS [°SHORE A]	TEMPERATURE RANGE [°C]	FEATURE
R1	92	-5 to +70	Standard
R2	85	-10 to +60	
R23T	90	-30 to +50	Low Temperature
FDA	85	-10 to +60	With Aramid Cord Only

### TECHNICAL DATA

STANDARD WIDTH (MM)	UNIT	10	16	25	32	50	75	100
<b>BREAKING FORCE / AVERAGE VALUE</b>								
Steel	[N]	2.565	4.275	7.125	9.120	14.535	21.945	29.355
Aramid	[N]	3.140	5.224	8.350	10.782	17.034	25.718	34.402
<b>ALLOWABLE BELT FORCE / OPEN ENDED</b>								
Steel	[N]	634	1.056	1.761	2.253	3.591	5.422	7.253
Aramid	[N]	455	757	1.210	1.562	2.468	3.727	4.985
<b>ALLOWABLE BELT FORCE / ENDLESS WELDED</b>								
Steel	[N]	317	528	880	1.127	1.796	2.711	3.627
Aramid	[N]	341	568	908	1.172	1.851	2.795	3.739
<b>ALLOWABLE EFFECTIVE FORCE / MINIMUM 12 TEETH IN MESH</b>								
	[N]	480	768	1.200	1.536	2.400	3.600	4.800
<b>BELT WEIGHT</b>								
Steel	[kg/m]	0,03	0,05	0,08	0,11	0,17	0,25	0,33
Aramid	[kg/m]	0,03	0,04	0,07	0,09	0,14	0,20	0,27
<b>SPECIFIC BELT STIFFNESS</b>								
Steel	[N]	158.445	264.075	440.125	563.360	897.855	1.355.585	1.813.315
Aramid	[N]	113.740	189.244	302.500	390.588	617.100	931.700	1.246.300

# ATL5 / PITCH: 5MM

## PRODUCT SPECIFICATIONS

<b>PITCH</b>	5 mm
<b>STANDARD THICKNESS</b>	2,7 mm
<b>WIDTH TOLERANCE</b>	
< 50MM WIDTH	+,-0,5 mm
> 50MM WIDTH	+,-0,75 mm
<b>MINIMUM WELDED BELT LENGTH</b>	480 mm
<b>STANDARD ROLL LENGTH (TOLERANCE ±1%)</b>	100 m
<b>STANDARD COLOR</b>	White
<b>FDA/EU APPROVAL</b>	No
<b>POLYAMIDE FABRIC</b>	Optional NT, NB & NTB

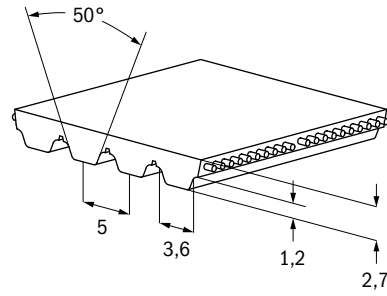

### MIN PULLEY DIAMETER:

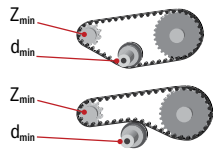

	STEEL
<b>z min</b>	15
<b>d min</b>	40
<b>z min</b>	15
<b>d min</b>	60

POLYURETHANE	HARDNESS [° SHORE A]	TEMPERATURE RANGE [°C]	FEATURE
R1	92	-5 to +70	Standard
R2	85	-10 to +60	
R23T	90	-30 to +50	Low Temperature

## TECHNICAL DATA

STANDARD WIDTH (MM)	UNIT	10	16	25	32	50	75	100	150
<b>BREAKING FORCE / AVERAGE VALUE</b>									
Steel	[N]	3.720	6.200	10.540	13.640	21.700	32.860	44.020	66.340
<b>ALLOWABLE BELT FORCE / OPEN ENDED</b>									
Steel	[N]	826	1.376	2.340	3.028	4.818	7.295	9.773	14.728
<b>ALLOWABLE BELT FORCE / ENDLESS WELDED</b>									
Steel	[N]	413	688	1.170	1.514	2.409	3.648	4.886	7.364
<b>ALLOWABLE EFFECTIVE FORCE / MINIMUM 12 TEETH IN MESH</b>									
	[N]	480	768	1.200	1.536	2.400	3.600	4.800	7.200
<b>BELT WEIGHT</b>									
Steel	[kg/m]	0,03	0,05	0,07	0,09	0,14	0,21	0,28	0,42
<b>SPECIFIC BELT STIFFNESS</b>									
Steel	[N]	206.471	344.118	585.000	757.059	1.204.412	1.823.824	2.443.235	3.682.059



**AT10 / PITCH: 10MM****PRODUCT SPECIFICATIONS**

<b>PITCH</b>	10 mm
<b>STANDARD THICKNESS</b>	
AT10	4,5 mm
AT10 HB	6,5 mm
<b>WIDTH TOLERANCE</b>	
< 50MM WIDTH	+,-0,75 mm
> 50MM WIDTH	+,-1,00 mm
<b>MINIMUM WELDED BELT LENGTH</b>	
< 100MM WIDTH	480 mm
> 100MM WIDTH	960 mm
<b>STANDARD ROLL LENGTH (TOLERANCE ±1%)</b>	100 m
<b>STANDARD COLOR</b>	White
<b>FDA/EU APPROVAL</b>	Option
<b>POLYAMIDE FABRIC</b>	Optional NT, NB & NTB

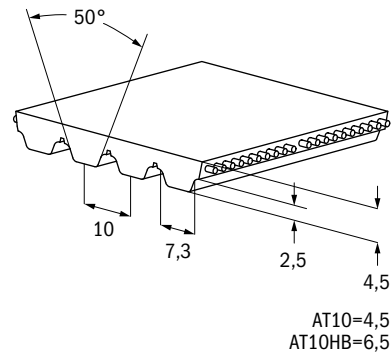
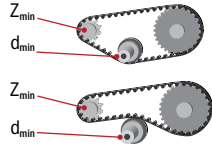
**MIN PULLEY DIAMETER:**

	STEEL	ARAMID	STEEL HF	STAINLESS STEEL
<b>z min</b>	15	15	12	20
<b>d min</b>	50	50	40	130
<b>z min</b>	25	25	20	30
<b>d min</b>	120	120	100	160

POLYURETHANE	HARDNESS [° SHORE A]	TEMPERATURE RANGE [° C]	FEATURE
R1	92	-5 to +70	Standard
R2	85	-10 to +60	
R23T	90	-30 to +50	Low Temperature
FDA	85	-10 to +60	With Aramid Cord Only

**TECHNICAL DATA**

STANDARD WIDTH (MM)	UNIT	16	25	32	50	75	100	150
<b>BREAKING FORCE / AVERAGE VALUE</b>								
Steel	[N]	8.550	14.250	18.050	29.450	44.650	59.850	90.250
Aramid	[N]	9.970	16.185	21.019	33.449	50.713	67.977	102.505
Steel HF	[N]	7.785	12.975	16.435	26.815	40.655	54.495	82.175
Stainless Steel	[N]	6.413	10.688	13.538	22.088	33.488	44.888	67.688
<b>ALLOWABLE BELT FORCE / OPEN ENDED</b>								
Steel	[N]	2.245	3.741	4.739	7.731	11.722	15.712	23.693
Aramid	[N]	1.032	1.675	2.175	3.461	5.247	7.033	10.606
Steel HF	[N]	1.944	3.240	4.104	6.696	10.152	13.608	20.520
Stainless Steel	[N]	1.683	2.806	3.554	5.799	8.791	11.784	17.770
<b>ALLOWABLE BELT FORCE / ENDLESS WELDED</b>								
Steel	[N]	1.122	1.871	2.369	3.866	5.861	7.856	11.847
Aramid	[N]	774	1.256	1.631	2.596	3.935	5.275	7.954
Steel HF	[N]	972	1.620	2.052	3.348	5.076	6.804	10.260
Stainless Steel	[N]	842	1.403	1.777	2.899	4.396	5.892	8.885
<b>ALLOWABLE EFFECTIVE FORCE / MINIMUM 12 TEETH IN MESH</b>								
	[N]	1.651	2.580	3.302	5.160	7.740	10.320	15.480
<b>BELT WEIGHT</b>								
Steel	[kg/m]	0,09	0,14	0,18	0,29	0,43	0,57	0,86
Aramid	[kg/m]	0,07	0,11	0,13	0,21	0,32	0,42	0,63
Steel HF	[kg/m]	0,09	0,14	0,18	0,27	0,41	0,55	0,82
Stainless Steel	[kg/m]	0,11	0,17	0,21	0,34	0,50	0,67	1,01
HB Steel	[kg/m]	0,13	0,20	0,26	0,40	0,60	0,80	1,21
HB Aramid	[kg/m]	0,10	0,16	0,21	0,33	0,49	0,65	0,98
HB Steel HF	[kg/m]	0,12	0,20	0,25	0,39	0,59	0,78	1,17
HB Stainless Steel	[kg/m]	0,14	0,23	0,29	0,45	0,68	0,90	1,35
<b>SPECIFIC BELT STIFFNESS</b>								
Steel	[N]	561.150	935.250	1.184.650	1.932.850	2.930.450	3.928.050	5.923.250
Aramid	[N]	257.888	418.650	543.687	865.210	1.311.770	1.758.330	2.651.450
Steel HF	[N]	486.000	810.000	1.026.000	1.674.000	2.538.000	3.402.000	5.130.000
Stainless Steel	[N]	420.863	701.438	888.488	1.449.638	2.197.838	2.946.038	4.442.438

# ATL10 / PITCH: 10MM

## PRODUCT SPECIFICATIONS

<b>PITCH</b>	10 mm
<b>STANDARD THICKNESS</b>	4,8 mm
<b>WIDTH TOLERANCE</b>	
< 50MM WIDTH	+,-1,00 mm
> 50MM WIDTH	+,-1,50 mm
<b>MINIMUM WELDED BELT LENGTH</b>	N/A
<b>STANDARD ROLL LENGTH (TOLERANCE ±1%)</b>	100 m
<b>STANDARD COLOR</b>	White
<b>FDA/EU APPROVAL</b>	No
<b>POLYAMIDE FABRIC</b>	Optional NT, NB & NTB

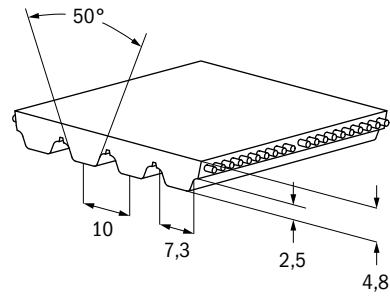

### MIN PULLEY DIAMETER:

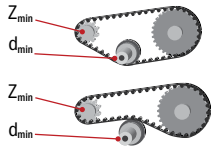

	STEEL	ARAMID	STEEL HF	STEEL RHF
<b>z min</b>	25	25	20	40
<b>d min</b>	80	80	70	127
<b>z min</b>	25	25	20	42
<b>d min</b>	150	150	130	200

POLYURETHANE	HARDNESS [° SHORE A]	TEMPERATURE RANGE [° C]	FEATURE
R1	92	-5 to +70	Standard
R2	85	-10 to +60	
R23T	90	-30 to +50	Low Temperature

## TECHNICAL DATA

STANDARD WIDTH (MM)	UNIT	16	25	32	50	75	100	150
<b>BREAKING FORCE / AVERAGE VALUE</b>								
Steel	[N]	13.840	24.220	31.140	50.170	76.120	102.070	153.970
Aramid	[N]	13.390	21.798	28.337	45.153	68.508	91.863	138.573
Steel HF	[N]	15.400	26.950	34.650	55.825	84.700	113.575	171.325
Steel RHF	[N]	N/A	41.250	52.250	82.500	123.750	165.000	247.500
<b>ALLOWABLE BELT FORCE / OPEN ENDED</b>								
Steel	[N]	3.349	5.860	7.534	12.139	18.147	24.696	37.253
Aramid	[N]	1.222	1.989	2.585	4.120	6.251	8.382	12.643
Steel HF	[N]	2.902	5.079	6.530	10.521	15.963	21.404	32.288
Steel RHF	[N]	N/A	9.600	12.160	19.200	28.800	38.400	57.600
<b>ALLOWABLE EFFECTIVE FORCE / MINIMUM 12 TEETH IN MESH</b>								
	[N]	1.651	2.580	3.302	5.160	7.740	10.320	15.480
<b>BELT WEIGHT</b>								
Steel	[kg/m]	0,11	0,17	0,21	0,34	0,50	0,67	1,01
Aramid	[kg/m]	0,07	0,10	0,13	0,21	0,31	0,41	0,62
Steel HF	[kg/m]	0,12	0,18	0,23	0,36	0,54	0,72	1,08
Steel RHF	[N]	N/A	0,21	0,27	0,42	0,63	0,85	1,27
<b>SPECIFIC BELT STIFFNESS</b>								
Steel	[N]	837.143	1.465.000	1.883.571	3.034.643	4.604.286	6.173.929	9.313.214
Aramid	[N]	305.429	497.210	646.373	1.029.935	1.562.660	2.095.385	3.160.836
Steel HF	[N]	725.571	1.269.750	1.632.536	2.630.196	3.990.643	5.351.089	8.071.982
Steel RHF	[N]	N/A	2.400.000	3.040.000	4.800.000	7.200.000	9.600.000	14.400.000

# AT20 / PITCH: 20MM

## PRODUCT SPECIFICATIONS

<b>PITCH</b>	20 mm
<b>STANDARD THICKNESS</b>	8,0 mm
<b>WIDTH TOLERANCE</b>	
< 50MM WIDTH	+,-1,00 mm
> 50MM WIDTH	+,-1,50 mm
<b>MINIMUM WELDED BELT LENGTH</b>	1.200 mm
<b>STANDARD ROLL LENGTH (TOLERANCE ±1%)</b>	50 m
<b>STANDARD COLOR</b>	White
<b>FDA/EU APPROVAL</b>	Option
<b>POLYAMIDE FABRIC</b>	Optional NT, NB & NTB

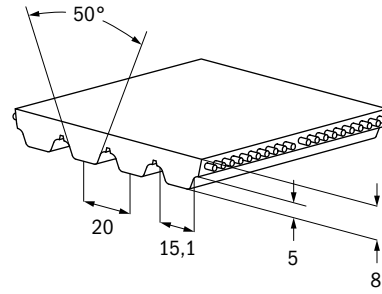

### MIN PULLEY DIAMETER:

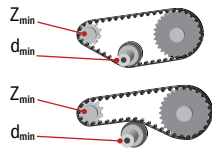

	STEEL	ARAMID
<b>z min</b>	18	18
<b>d min</b>	120	120
<b>z min</b>	25	25
<b>d min</b>	180	180

POLYURETHANE	HARDNESS [° SHORE A]	TEMPERATURE RANGE [° C]	FEATURE
R1	92	-5 to +70	Standard
R2	85	-10 to +60	
R23T	90	-30 to +50	Low Temperature
FDA	85	-10 to +60	With Aramid Cord Only

## TECHNICAL DATA

STANDARD WIDTH (MM)	UNIT	25	32	50	75	100	150
<b>BREAKING FORCE / AVERAGE VALUE</b>							
Steel	[N]	24.220	31.140	50.170	76.120	102.070	153.970
Aramid	[N]	21.798	28.337	45.153	68.508	91.863	138.573
<b>ALLOWABLE BELT FORCE / OPEN ENDED</b>							
Steel	[N]	5.860	7.534	12.139	18.417	24.696	37.253
Aramid	[N]	1.989	2.585	4.120	6.251	8.382	12.643
<b>ALLOWABLE BELT FORCE / ENDLESS WELDED</b>							
Steel	[N]	2.930	3.767	6.069	9.209	12.348	18.626
Aramid	[N]	1.492	1.939	3.090	4.688	6.286	9.483
<b>ALLOWABLE EFFECTIVE FORCE / MINIMUM 12 TEETH IN MESH</b>							
	[N]	5.450	6.976	10.900	16.350	21.800	32.700
<b>BELT WEIGHT</b>							
Steel	[kg/m]	0,24	0,31	0,48	0,73	0,97	1,45
Aramid	[kg/m]	0,18	0,23	0,37	0,55	0,73	1,10
<b>SPECIFIC BELT STIFFNESS</b>							
Steel	[N]	1.465.000	1.883.571	3.034.643	4.604.286	6.173.929	9.313.214
Aramid	[N]	497.210	646.373	1.029.935	1.562.660	2.095.385	3.160.836

**ATL20 / PITCH: 20MM**

**PRODUCT SPECIFICATIONS**

<b>PITCH</b>	20 mm
<b>STANDARD THICKNESS</b>	8,0 mm
<b>WIDTH TOLERANCE</b>	+2,00 mm
<b>MINIMUM WELDED BELT LENGTH</b>	NA
<b>STANDARD ROLL LENGTH (TOLERANCE ±1%)</b>	50 m
<b>STANDARD COLOR</b>	White
<b>FDA/EU APPROVAL</b>	No
<b>POLYAMIDE FABRIC</b>	Optional NT, NB & NTB

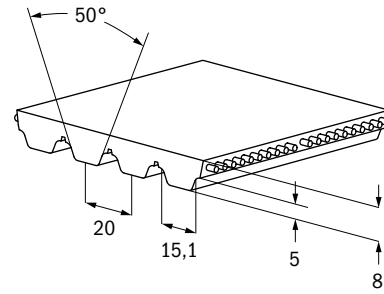

**MIN PULLEY DIAMETER:**

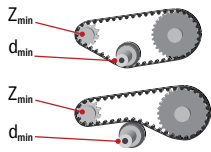

	STEEL
<b>z min</b>	25
<b>d min</b>	159
<b>z min</b>	25
<b>d min</b>	250

POLYURETHANE	HARDNESS [° SHORE A]	TEMPERATURE RANGE [° C]	FEATURE
R1	92	-5 to +70	Standard
R2	85	-10 to +60	
R23T	90	-30 to +50	Low Temperature

**TECHNICAL DATA**

STANDARD WIDTH (MM)	UNIT	32	50	75	100	150
<b>BREAKING FORCE / AVERAGE VALUE</b>						
Steel	[N]	41.600	70.400	105.600	144.000	217.600
<b>ALLOWABLE BELT FORCE / OPEN ENDED</b>						
Steel	[N]	9.106	15.410	23.115	31.520	47.631
<b>ALLOWABLE EFFECTIVE FORCE / MINIMUM 12 TEETH IN MESH</b>						
	[N]	6.976	10.900	16.350	21.800	32.700
<b>BELT WEIGHT</b>						
Steel	[kg/m]	0,35	0,54	0,81	1,08	1,63
<b>SPECIFIC BELT STIFFNESS</b>						
Steel	[N]	2.276.477	3.852.500	5.778.749	7.880.113	11.907.726



**HTD5 / PITCH: 5MM****PRODUCT SPECIFICATIONS**

<b>PITCH</b>	5 mm
<b>STANDARD THICKNESS</b>	3,6 mm
<b>WIDTH TOLERANCE</b>	
< 50MM WIDTH	+0,5 mm
> 50MM WIDTH	+0,75 mm
<b>MINIMUM WELDED BELT LENGTH</b>	
< 100MM WIDTH	480 mm
> 100MM WIDTH	960 mm
<b>STANDARD ROLL LENGTH (TOLERANCE ±1%)</b>	100 m
<b>STANDARD COLOR</b>	White
<b>FDA/EU APPROVAL</b>	Option
<b>POLYAMIDE FABRIC</b>	Optional NT, NB & NTB

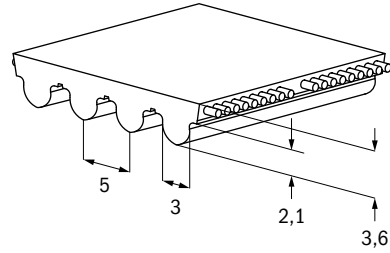
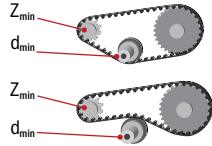
**MIN PULLEY DIAMETER:**

	STEEL	STEEL BASIC	ARAMID
<b>z min</b>	14	16	16
<b>d min</b>	22	25	25
<b>z min</b>	14	16	16
<b>d min</b>	60	80	80

POLYURETHANE	HARDNESS [° SHORE A]	TEMPERATURE RANGE [° C]	FEATURE
R1	92	-5 to +70	Standard
R2	85	-10 to +60	
R23T	90	-30 to +50	Low Temperature
FDA	85	-10 to +60	With Aramid Cord Only

**TECHNICAL DATA**

STANDARD WIDTH (MM)	UNIT	10	15	20	25	30	50	100	150
<b>BREAKING FORCE / AVERAGE VALUE</b>									
Steel basic	[N]	2.520	3.780	5.460	7.140	8.400	14.700	29.820	44.940
Steel	[N]	3.720	5.580	8.060	10.540	12.400	21.700	44.020	66.340
Aramid	[N]	2.911	4.635	6.360	8.085	9.810	16.709	33.957	51.205
<b>ALLOWABLE BELT FORCE / OPEN ENDED</b>									
Steel basic	[N]	674	1.010	1.459	1.909	2.245	3.929	7.971	12.012
Steel	[N]	826	1.239	1.789	2.340	2.753	4.818	9.773	14.728
Aramid	[N]	383	610	837	1.064	1.290	2.198	4.467	6.736
<b>ALLOWABLE BELT FORCE / ENDLESS WELDED</b>									
Steel basic	[N]	337	505	730	954	1.123	1.965	3.985	6.006
Steel	[N]	413	619	895	1.170	1.224	2.409	4.886	7.364
Aramid	[N]	287	457	627	798	968	1.648	3.350	5.052
<b>ALLOWABLE EFFECTIVE FORCE / MINIMUM 12 TEETH IN MESH</b>									
	[N]	450	675	900	1.125	1.350	2.250	4.500	6.750
<b>BELT WEIGHT</b>									
Steel basic	[kg/m]	0,04	0,07	0,09	0,11	0,13	0,22	0,44	0,66
Steel	[kg/m]	0,05	0,07	0,10	0,12	0,15	0,25	0,49	0,74
Aramid	[kg/m]	0,03	0,04	0,06	0,07	0,09	0,15	0,29	0,44
<b>SPECIFIC BELT STIFFNESS</b>									
Steel basic	[N]	168.397	252.596	364.860	477.125	561.324	982.316	1.992.699	3.003.081
Steel	[N]	206.471	309.706	447.353	585.000	688.235	1.204.412	2.443.235	3.682.059
Aramid	[N]	95.715	152.435	209.155	265.875	322.595	549.475	1.116.675	1.683.875

# HTD8 / PITCH: 8MM

### PRODUCT SPECIFICATIONS

<b>PITCH</b>	8 mm
<b>STANDARD THICKNESS</b>	5,6 mm
<b>WIDTH TOLERANCE</b>	
< 50MM WIDTH	+0,75 mm
> 50MM WIDTH	+1,00 mm
<b>MINIMUM WELDED BELT LENGTH</b>	
< 100MM WIDTH	552 mm
> 100MM WIDTH	960 mm
<b>STANDARD ROLL LENGTH (TOLERANCE ±1%)</b>	100 m
<b>STANDARD COLOR</b>	White
<b>FDA/EU APPROVAL</b>	Option
<b>POLYAMIDE FABRIC</b>	Optional NT, NB & NTB

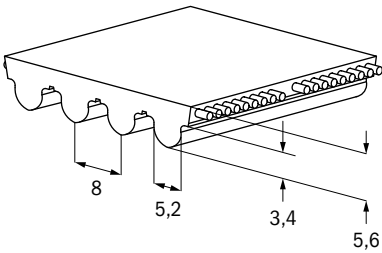

### MIN PULLEY DIAMETER:

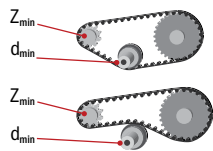

	STEEL	ARAMID	STEEL HF	STAINLESS
<b>z min</b>	20	20	16	25
<b>d min</b>	50	50	40	80
<b>z min</b>	22	22	20	28
<b>d min</b>	110	110	100	150

POLYURETHANE	HARDNESS [° SHORE A]	TEMPERATURE RANGE [°C]	FEATURE
R1	92	-5 to +70	Standard
R2	85	-10 to +60	
R23T	90	-30 to +50	Low Temperature
FDA	85	-10 to +60	With Aramid Cord Only

### TECHNICAL DATA

STANDARD WIDTH (MM)	UNIT	10	15	20	25	30	50	85	100	150
<b>BREAKING FORCE / AVERAGE VALUE</b>										
Steel	[N]	4.750	7.600	10.450	14.250	17.100	29.450	50.350	59.850	90.250
Aramid	[N]	5.827	9.279	12.732	16.185	19.638	33.449	57.619	67.977	102.505
Steel HF	[N]	4.325	6.920	9.515	12.975	15.570	26.815	45.845	54.495	82.175
Stainless	[N]	3.563	5.700	7.838	10.688	12.825	22.088	37.763	44.888	67.688
<b>ALLOWABLE BELT FORCE / OPEN ENDED</b>										
Steel	[N]	1.247	1.995	2.743	3.741	4.489	7.731	13.218	15.712	23.693
Aramid	[N]	603	960	1.317	1.675	2.032	3.461	5.962	7.033	10.606
Steel HF	[N]	1.152	1.843	2.534	3.456	4.147	7.142	12.211	14.515	21.888
Stainless	[N]	935	1.496	2.058	2.806	3.367	5.799	9.914	11.784	17.770
<b>ALLOWABLE BELT FORCE / ENDLESS WELDED</b>										
Steel	[N]	624	998	1.372	1.871	2.245	3.866	6.609	7.856	11.847
Aramid	[N]	452	720	988	1.256	1.524	2.596	4.471	5.275	7.954
Steel HF	[N]	576	922	1.267	1.728	2.074	3.571	6.106	7.258	10.944
Stainless	[N]	468	748	1.029	1.403	1.683	2.899	4.957	5.892	8.885
<b>ALLOWABLE EFFECTIVE FORCE / MINIMUM 12 TEETH IN MESH</b>										
	[N]	930	1.395	1.860	2.325	2.790	4.650	7.905	9.300	13.950
<b>BELT WEIGHT</b>										
Steel	[kg/m]	0,07	0,10	0,14	0,17	0,21	0,34	0,58	0,69	1,03
Aramid	[kg/m]	0,05	0,07	0,09	0,12	0,14	0,24	0,40	0,47	0,71
Steel HF	[kg/m]	0,07	0,10	0,13	0,17	0,20	0,33	0,56	0,66	0,99
Stainless	[kg/m]	0,07	0,10	0,14	0,17	0,20	0,34	0,58	0,68	1,02
<b>SPECIFIC BELT STIFFNESS</b>										
Steel	[N]	311.750	498.800	685.850	935.250	1.122.300	1.932.850	3.304.550	3.928.050	5.923.250
Aramid	[N]	157.500	250.833	344.167	437.500	530.833	904.167	1.557.500	1.837.500	2.770.833
Steel HF	[N]	288.000	460.800	633.600	864.000	1.036.800	1.785.600	3.052.800	3.628.800	5.472.000
Stainless	[N]	233.813	374.100	514.388	701.438	841.725	1.449.638	2.478.413	2.946.038	4.442.438

**HTDL8 / PITCH: 8MM****PRODUCT SPECIFICATIONS**

<b>PITCH</b>	8 mm
<b>STANDARD THICKNESS</b>	5,6 mm
<b>WIDTH TOLERANCE</b>	
< 50MM WIDTH	+,-1,00 mm
> 50MM WIDTH	+,-1,50 mm
<b>MINIMUM WELDED BELT LENGTH</b>	NA
<b>STANDARD ROLL LENGTH (TOLERANCE ±1%)</b>	100 m
<b>STANDARD COLOR</b>	White
<b>FDA/EU APPROVAL</b>	No
<b>POLYAMIDE FABRIC</b>	Optional NT, NB & NTB

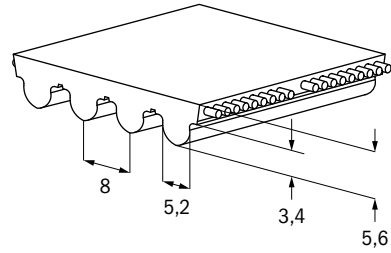
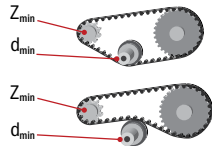
**MIN PULLEY DIAMETER:**

	STEEL	ARAMID	STEEL HF
<b>z min</b>	32	32	25
<b>d min</b>	90	90	70
<b>z min</b>	34	34	30
<b>d min</b>	150	150	130

POLYURETHANE	HARDNESS [° SHORE A]	TEMPERATURE RANGE [° C]	FEATURE
R1	92	-5 to +70	Standard
R2	85	-10 to +60	
R23T	90	-30 to +50	Low Temperature

**TECHNICAL DATA**

STANDARD WIDTH (MM)	UNIT	20	25	30	50	85	100	150
<b>BREAKING FORCE / AVERAGE VALUE</b>								
Steel	[N]	19.030	24.220	29.410	50.170	86.500	102.070	153.970
Aramid	[N]	17.127	21.798	26.469	45.153	77.850	91.863	138.573
Steel HF	[N]	21.175	26.950	32.725	55.825	96.250	113.575	171.325
<b>ALLOWABLE BELT FORCE / OPEN ENDED</b>								
Steel	[N]	4.604	5.860	7.116	12.139	20.929	24.696	37.253
Aramid	[N]	1.563	1.989	2.415	4.120	7.103	8.382	12.643
Steel HF	[N]	3.991	5.079	6.167	10.521	18.139	21.404	32.288
<b>ALLOWABLE EFFECTIVE FORCE / MINIMUM 12 TEETH IN MESH</b>								
	[N]	1.860	2.325	2.790	4.650	7.905	9.300	13.950
<b>BELT WEIGHT</b>								
Steel	[kg/m]	0,16	0,20	0,24	0,39	0,67	0,79	1,18
Aramid	[kg/m]	0,09	0,11	0,14	0,23	0,38	0,45	0,68
Steel HF	[kg/m]	0,17	0,21	0,25	0,42	0,71	0,83	1,25
<b>SPECIFIC BELT STIFFNESS</b>								
Steel	[N]	1.151.071	1.465.000	1.778.929	3.034.643	5.232.143	6.173.929	9.313.214
Aramid	[N]	390.665	497.210	603.755	1.029.935	1.775.750	2.095.385	3.160.836
Steel HF	[N]	997.661	1.269.750	1.541.839	2.630.196	4.534.821	5.351.089	8.071.982

# HTD14 / PITCH: 14MM

### PRODUCT SPECIFICATIONS

<b>PITCH</b>	14 mm
<b>STANDARD THICKNESS</b>	10 mm
<b>WIDTH TOLERANCE</b>	
< 50MM WIDTH	+,-1,00 mm
50 TO 100MM WIDTH	+,-1,50 mm
> 100 MM WIDTH	+,-2,00 mm
<b>MINIMUM WELDED BELT LENGTH</b>	1.200 mm
<b>STANDARD ROLL LENGTH (TOLERANCE ±1%)</b>	50 m
<b>STANDARD COLOR</b>	White
<b>FDA/EU APPROVAL</b>	No
<b>POLYAMIDE FABRIC</b>	Optional NT, NB & NTB

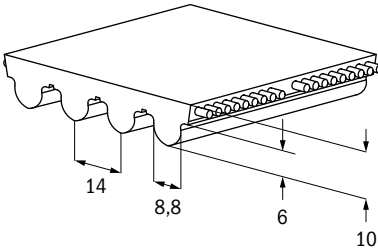

### MIN PULLEY DIAMETER:

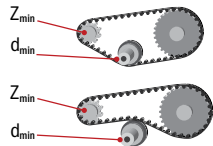

	STEEL	ARAMID	STEEL HF
<b>z min</b>	26	26	23
<b>d min</b>	120	120	100
<b>z min</b>	28	28	25
<b>d min</b>	180	180	160

POLYURETHANE	HARDNESS [° SHORE A]	TEMPERATURE RANGE [° C]	FEATURE
R1	92	-5 to +70	Standard
R2	85	-10 to +60	
R23T	90	-30 to +50	Low Temperature

### TECHNICAL DATA

STANDARD WIDTH (MM)	UNIT	25	40	55	85	115	170
<b>BREAKING FORCE / AVERAGE VALUE</b>							
Steel	[N]	20.760	34.600	48.440	74.390	102.070	152.240
Aramid	[N]	18.995	31.327	43.658	68.321	92.984	138.199
Steel HF	[N]	23.100	38.500	53.900	82.775	113.575	169.400
<b>ALLOWABLE BELT FORCE / OPEN ENDED</b>							
Steel	[N]	5.156	8.593	12.031	18.476	25.350	37.811
Aramid	[N]	1.733	2.858	3.983	6.234	8.484	12.609
Steel HF	[N]	4.470	7.449	10.429	16.016	21.975	32.776
<b>ALLOWABLE BELT FORCE / ENDLESS WELDED</b>							
Steel	[N]	2.578	4.297	6.015	9.238	12.675	18.905
Aramid	[N]	1.300	2.144	2.988	4.675	6.363	9.457
Steel HF	[N]	2.235	3.725	5.214	8.008	10.988	16.388
<b>ALLOWABLE EFFECTIVE FORCE / MINIMUM 12 TEETH IN MESH</b>							
	[N]	4.313	6.900	9.488	14.663	19.838	29.325
<b>BELT WEIGHT</b>							
Steel	[kg/m]	0,27	0,43	0,60	0,92	1,24	1,84
Aramid	[kg/m]	0,21	0,34	0,46	0,71	0,97	1,43
Steel HF	[kg/m]	0,28	0,45	0,62	0,96	1,29	1,91
<b>SPECIFIC BELT STIFFNESS</b>							
Steel	[N]	1.289.000	2.148.333	3.007.667	4.618.917	6.337.583	9.452.667
Aramid	[N]	433.283	714.562	995.841	1.558.398	2.120.956	3.152.312
Steel HF	[N]	1.117.380	1.862.300	2.607.220	4.003.945	5.493.785	8.194.120



**HTDL14 / PITCH: 14MM****PRODUCT SPECIFICATIONS**

<b>PITCH</b>	14 mm
<b>STANDARD THICKNESS</b>	10 mm
<b>WIDTH TOLERANCE</b>	
< 50MM WIDTH	+1,00 mm
50 TO 100MM WIDTH	+1,50 mm
> 100 MM WIDTH	+2,00 mm
<b>MINIMUM WELDED BELT LENGTH</b>	N/A
<b>STANDARD ROLL LENGTH (TOLERANCE ±1%)</b>	50 m
<b>STANDARD COLOR</b>	White
<b>FDA/EU APPROVAL</b>	No
<b>POLYAMIDE FABRIC</b>	Optional NT, NB & NTB

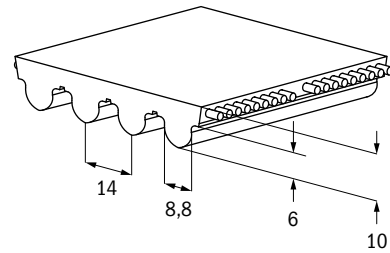
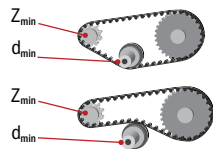
**MIN PULLEY DIAMETER:**

	STEEL
<b>z min</b>	34
<b>d min</b>	160
<b>z min</b>	36
<b>d min</b>	200

POLYURETHANE	HARDNESS [°SHORE A]	TEMPERATURE RANGE [°C]	FEATURE
R1	92	-5 to +70	Standard
R2	85	-10 to +60	
R23T	90	-30 to +50	Low Temperature

**TECHNICAL DATA**

STANDARD WIDTH (MM)	UNIT	55	85	115	170
<b>BREAKING FORCE / AVERAGE VALUE</b>					
Steel	[N]	76.800	121.600	163.200	246.400
<b>ALLOWABLE BELT FORCE / OPEN ENDED</b>					
Steel	[N]	16.811	26.617	35.723	53.935
<b>ALLOWABLE EFFECTIVE FORCE / MINIMUM 12 TEETH IN MESH</b>					
	[N]	9.488	14.663	19.838	29.325
<b>BELT WEIGHT</b>					
Steel	[kg/m]	0,68	1,04	1,41	2,09
<b>SPECIFIC BELT STIFFNESS</b>					
Steel	[N]	4.202.727	6.654.318	8.930.795	13.483.750

# HPL3 / PITCH: 3MM

## PRODUCT SPECIFICATIONS

<b>PITCH</b>	3 mm
<b>STANDARD THICKNESS</b>	2,6 mm
<b>WIDTH TOLERANCE</b>	
< 50MM WIDTH	+,-0,5 mm
> 50MM WIDTH	+,-0,75 mm
<b>MINIMUM WELDED BELT LENGTH</b>	N/A
<b>STANDARD ROLL LENGTH (TOLERANCE ±1%)</b>	100 m
<b>STANDARD COLOR</b>	White
<b>FDA/EU APPROVAL</b>	No
<b>POLYAMIDE FABRIC</b>	Optional NT, NB & NTB

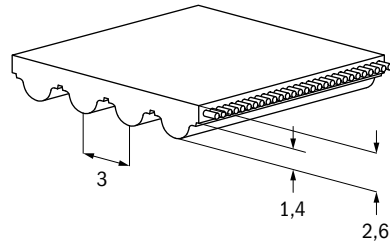

## PULLEY DEFINITION

HPL3 BELT RUNS IN GATES 3MGT PULLEY PROFILE

MIN PULLEY DIAMETER:

	STEEL
<b>z min</b>	25
<b>d min</b>	24
<b>z min</b>	27
<b>d min</b>	60

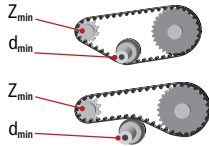

POLYURETHANE	HARDNESS [° SHORE A]	TEMPERATURE RANGE [° C]	FEATURE
R1	92	-5 to +70	Standard

## TECHNICAL DATA

STANDARD WIDTH (MM)	UNIT	16	25	32	50	75	100
<b>BREAKING FORCE / AVERAGE VALUE</b>							
Steel	[N]	4.275	7.125	9.120	14.535	21.945	29.355
<b>ALLOWABLE BELT FORCE / OPEN ENDED</b>							
Steel	[N]	1.056	1.761	2.253	3.591	6.335	7.253
<b>ALLOWABLE EFFECTIVE FORCE / MINIMUM 12 TEETH IN MESH</b>							
	[N]	448	700	896	1.400	2.100	2.800
<b>BELT WEIGHT</b>							
Steel	[kg/m]	0,05	0,07	0,09	0,15	0,22	0,29
<b>SPECIFIC BELT STIFFNESS</b>							
Steel	[N]	264.075	440.125	563.360	897.855	1.583.690	1.813.315

**HPL5 / PITCH: 5MM****PRODUCT SPECIFICATIONS**

<b>PITCH</b>	5 mm
<b>STANDARD THICKNESS</b>	3,8 mm
<b>WIDTH TOLERANCE</b>	
< 50MM WIDTH	+0,5 mm
> 50MM WIDTH	+0,75 mm
<b>MINIMUM WELDED BELT LENGTH</b>	N/A
<b>STANDARD ROLL LENGTH (TOLERANCE ±1%)</b>	100 m
<b>STANDARD COLOR</b>	White
<b>FDA/EU APPROVAL</b>	No
<b>POLYAMIDE FABRIC</b>	Optional NT, NB & NTB

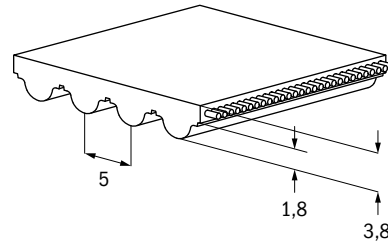
**PULLEY DEFINITION**

HPL5 BELT RUNS IN GATES 5MGT PULLEY PROFILE

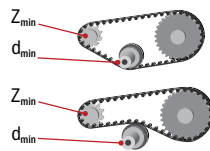
**MIN PULLEY DIAMETER:**

	STEEL
<b>z min</b>	24
<b>d min</b>	39
<b>z min</b>	28
<b>d min</b>	100

POLYURETHANE	HARDNESS [°SHORE A]	TEMPERATURE RANGE [°C]	FEATURE
R1	92	-5 to +70	Standard

**TECHNICAL DATA**

STANDARD WIDTH (MM)	UNIT	25	30	50	75	100	150
<b>BREAKING FORCE / AVERAGE VALUE</b>							
Steel	[N]	12.975	15.570	26.815	40.655	54.495	82.175
<b>ALLOWABLE BELT FORCE / OPEN ENDED</b>							
Steel	[N]	3.456	4.147	7.142	10.829	14.515	21.888
<b>ALLOWABLE EFFECTIVE FORCE / MINIMUM 12 TEETH IN MESH</b>							
	[N]	1.138	1.365	2.275	3.413	4.550	6.825
<b>BELT WEIGHT</b>							
Steel	[kg/m]	0,12	0,14	0,23	0,35	0,46	0,69
<b>SPECIFIC BELT STIFFNESS</b>							
Steel	[N]	864.000	1.036.800	1.785.600	2.707.200	3.628.800	5.472.000

# HPL8 / PITCH: 8MM

## PRODUCT SPECIFICATIONS

<b>PITCH</b>	8 mm
<b>STANDARD THICKNESS</b>	5,7 mm
<b>WIDTH TOLERANCE</b>	
< 50MM WIDTH	+,-1,0 mm
> 50MM WIDTH	+,-1,5 mm
<b>MINIMUM WELDED BELT LENGTH</b>	N/A
<b>STANDARD ROLL LENGTH (TOLERANCE ±1%)</b>	100 m
<b>STANDARD COLOR</b>	White
<b>FDA/EU APPROVAL</b>	No
<b>POLYAMIDE FABRIC</b>	Optional NT, NB & NTB

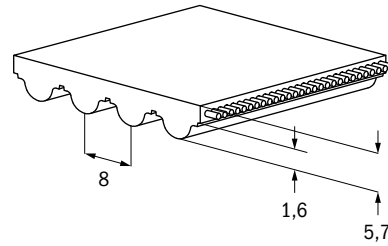

## PULLEY DEFINITION

HPL8 BELT RUNS IN GATES HTD8 AND 8MR PULLEY PROFILE

MIN PULLEY DIAMETER:

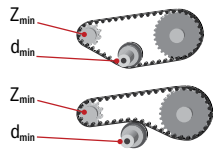

	STEEL	STEEL HF
<b>z min</b>	32	25
<b>d min</b>	90	70
<b>z min</b>	34	30
<b>d min</b>	150	130

POLYURETHANE	HARDNESS [° SHORE A]	TEMPERATURE RANGE [°C]	FEATURE
R1	92	-5 to +70	Standard

## TECHNICAL DATA

STANDARD WIDTH (MM)	UNIT	20	25	30	50	85	100	150
<b>BREAKING FORCE / AVERAGE VALUE</b>								
Steel	[N]	19.030	24.220	29.410	50.170	86.500	102.070	153.970
Steel HF	[N]	21.175	26.950	32.725	55.825	96.250	113.575	171.325
<b>ALLOWABLE BELT FORCE / OPEN ENDED</b>								
Steel	[N]	4.604	5.860	7.116	12.139	20.929	24.696	37.253
Steel HF	[N]	3.991	5.079	6.167	10.521	18.139	21.404	32.288
<b>ALLOWABLE EFFECTIVE FORCE / MINIMUM 15 TEETH IN MESH</b>								
	[N]	1.900	2.375	2.850	4.750	8.075	9.500	14.250
<b>BELT WEIGHT</b>								
Steel	[kg/m]	0,16	0,20	0,24	0,39	0,67	0,79	1,18
Steel HF	[kg/m]	0,17	0,21	0,25	0,42	0,71	0,83	1,25
<b>SPECIFIC BELT STIFFNESS</b>								
Steel	[N]	1.151.071	1.465.000	1.778.929	3.034.643	5.232.143	6.173.929	9.313.214
Steel HF	[N]	997.661	1.269.750	1.541.839	2.630.196	4.534.821	5.351.089	8.071.982

**STD5 / PITCH: 5MM****PRODUCT SPECIFICATIONS**

<b>PITCH</b>	5 mm
<b>STANDARD THICKNESS</b>	3,3 mm
<b>WIDTH TOLERANCE</b>	+0,5 mm
<b>MINIMUM WELDED BELT LENGTH</b>	480 mm
<b>STANDARD ROLL LENGTH (TOLERANCE ±1%)</b>	100 m
<b>STANDARD COLOR</b>	White
<b>FDA/EU APPROVAL</b>	No
<b>POLYAMIDE FABRIC</b>	Optional NT, NB & NTB

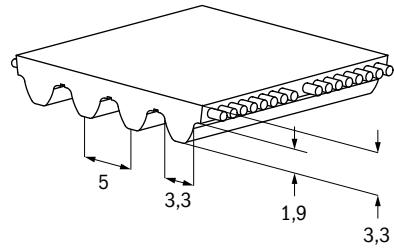
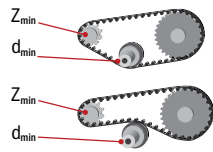
**MIN PULLEY DIAMETER:**

	<b>STEEL</b>	<b>ARAMID</b>
<b>z min</b>	14	16
<b>d min</b>	22	25
<b>z min</b>	14	16
<b>d min</b>	60	80

<b>POLYURETHANE</b>	<b>HARDNESS [° SHORE A]</b>	<b>TEMPERATURE RANGE [° C]</b>	<b>FEATURE</b>
R1	92	-5 to +70	Standard
R2	85	-10 to +60	

**TECHNICAL DATA**

<b>STANDARD WIDTH (MM)</b>	<b>UNIT</b>	<b>10</b>	<b>15</b>	<b>20</b>	<b>25</b>	<b>30</b>	<b>50</b>
<b>BREAKING FORCE / AVERAGE VALUE</b>							
Steel	[N]	3.720	5.580	8.060	10.540	12.400	21.700
Aramid	[N]	2.911	4.635	6.360	8.085	9.810	16.709
<b>ALLOWABLE BELT FORCE / OPEN ENDED</b>							
Steel	[N]	826	1.239	1.789	2.340	2.753	4.818
Aramid	[N]	383	610	837	1.064	1.290	2.198
<b>ALLOWABLE BELT FORCE / ENDLESS WELDED</b>							
Steel	[N]	413	619	895	1.170	1.376	2.409
Aramid	[N]	287	457	627	798	968	1.648
<b>ALLOWABLE EFFECTIVE FORCE / MINIMUM 12 TEETH IN MESH</b>							
	[N]	410	615	820	1.025	1.230	2.050
<b>BELT WEIGHT</b>							
Steel	[kg/m]	0,04	0,06	0,08	0,09	0,11	0,19
Aramid	[kg/m]	0,03	0,04	0,06	0,07	0,09	0,15
<b>SPECIFIC BELT STIFFNESS</b>							
Steel	[N]	206.471	309.706	447.353	585.000	688.235	1.204.412
Aramid	[N]	95.715	152.435	209.155	265.875	322.595	549.475

# STD8 / PITCH: 8MM

## PRODUCT SPECIFICATIONS

<b>PITCH</b>	8 mm
<b>STANDARD THICKNESS</b>	5,1 mm
<b>WIDTH TOLERANCE</b>	
< 50MM WIDTH	+0,75 mm
> 50MM WIDTH	+1,00 mm
<b>MINIMUM WELDED BELT LENGTH</b>	
< 100 MM WIDTH	552 mm
> 100 MM WIDTH	960 mm
<b>STANDARD ROLL LENGTH (TOLERANCE ±1%)</b>	100 m
<b>STANDARD COLOR</b>	White
<b>FDA/EU APPROVAL</b>	Option
<b>POLYAMIDE FABRIC</b>	Optional NT, NB & NTB

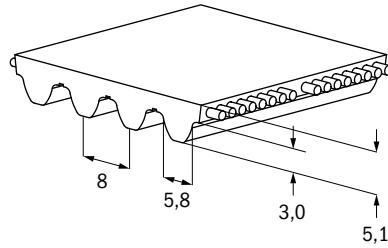

### MIN PULLEY DIAMETER:

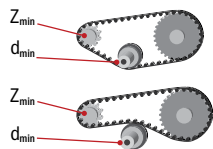

	STEEL	ARAMID	STEEL HF	STAINLESS
<b>z min</b>	20	20	16	25
<b>d min</b>	50	50	40	80
<b>z min</b>	22	22	20	28
<b>d min</b>	110	110	100	150

POLYURETHANE	HARDNESS [°SHORE A]	TEMPERATURE RANGE [°C]	FEATURE
R1	92	-5 to +70	Standard
R2	85	-10 to +60	
R23T	90	-30 to +50	Low Temperature
FDA	85	-10 to +60	With Aramid cord only

### TECHNICAL DATA

STANDARD WIDTH (MM)	UNIT	10	15	20	25	30	50	85	100	150
<b>BREAKING FORCE / AVERAGE VALUE</b>										
Steel	[N]	5.700	9.500	12.350	14.250	19.000	34.200	57.000	68.400	102.600
Aramid	[N]	5.827	9.279	12.732	16.185	19.638	33.449	57.619	67.977	102.505
Steel HF	[N]	5.190	8.650	11.245	12.975	17.300	31.140	51.900	62.280	93.420
Stainless	[N]	4.275	7.125	9.263	10.688	14.250	25.650	42.750	51.300	76.950
<b>ALLOWABLE BELT FORCE / OPEN ENDED</b>										
Steel	[N]	1.496	2.494	3.242	3.741	4.988	8.978	14.964	17.957	26.935
Aramid	[N]	630	1.003	1.377	1.750	2.123	3.617	6.230	7.350	11.083
Steel HF	[N]	1.382	2.304	2.995	3.456	4.608	8.294	13.824	16.589	24.883
Stainless	[N]	1.122	1.871	2.432	2.806	3.741	6.734	11.223	13.468	20.201
<b>ALLOWABLE BELT FORCE / ENDLESS WELDED</b>										
Steel	[N]	748	1.247	1.621	1.871	2.494	4.489	7.482	8.978	13.468
Aramid	[N]	473	753	1.033	1.313	1.593	2.713	4.673	5.513	8.313
Steel HF	[N]	691	1.152	1.498	1.728	2.304	4.147	6.912	8.294	12.442
Stainless	[N]	561	935	1.216	1.403	1.871	3.367	5.612	6.734	10.101
<b>ALLOWABLE EFFECTIVE FORCE / MINIMUM 12 TEETH IN MESH</b>										
	[N]	880	1.320	1.760	2.200	2.640	4.400	7.480	8.800	13.200
<b>BELT WEIGHT</b>										
Steel	[kg/m]	0,07	0,10	0,14	0,17	0,21	0,34	0,58	0,69	1,03
Aramid	[kg/m]	0,05	0,07	0,09	0,12	0,14	0,24	0,40	0,47	0,71
Steel HF	[kg/m]	0,07	0,10	0,13	0,17	0,20	0,33	0,56	0,66	0,99
Stainless	[kg/m]	0,07	0,10	0,14	0,17	0,20	0,34	0,58	0,68	1,02
<b>SPECIFIC BELT STIFFNESS</b>										
Steel	[N]	374.100	623.500	810.550	935.250	1.247.000	2.244.600	3.741.000	4.489.200	6.733.800
Aramid	[N]	157.500	250.833	344.167	437.500	530.833	904.167	1.557.500	1.837.500	2.770.833
Steel HF	[N]	345.600	460.800	633.600	864.000	1.036.800	1.785.600	3.052.800	3.628.800	5.472.000
Stainless	[N]	280.575	467.625	607.913	701.438	935.250	1.683.450	2.805.750	3.366.900	5.050.350



**GPP8 / PITCH: 8MM****PRODUCT SPECIFICATIONS**

<b>PITCH</b>	8 mm
<b>STANDARD THICKNESS</b>	5,4 mm
<b>WIDTH TOLERANCE</b>	+ - 0,50 mm
<b>MINIMUM WELDED BELT LENGTH</b>	960 mm
<b>STANDARD ROLL LENGTH (TOLERANCE ±1%)</b>	100 m
<b>STANDARD COLOR</b>	White
<b>FDA/EU APPROVAL</b>	No
<b>POLYAMIDE FABRIC</b>	
STANDARD	NT
OPTIONAL	NTB

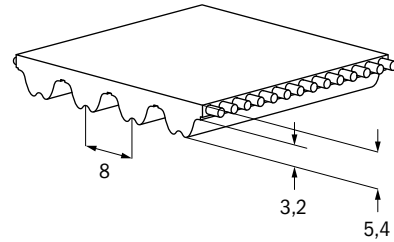
**PULLEY DEFINITION**

GPP8 BELT RUNS IN RPP8 AND HTD8M PULLEY PROFILE

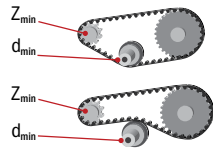
**MIN PULLEY DIAMETER:**

	STEEL	STEEL HF	STAINLESS
<b>z min</b>	20	16	25
<b>d min</b>	50	41	64
<b>z min</b>	22	20	28
<b>d min</b>	110	100	150

POLYURETHANE	HARDNESS [°SHORE A]	TEMPERATURE RANGE [°C]	FEATURE
R1	92	-5 to +70	Standard
R23T	90	-30 to +50	Low Temperature

**TECHNICAL DATA**

STANDARD WIDTH (MM)	UNIT	10	15	20	25	30	50	85	100	150
<b>BREAKING FORCE / AVERAGE VALUE</b>										
Steel	[N]	5.700	8.550	12.350	15.200	19.000	32.300	56.050	66.500	98.800
Steel HF	[N]	5.190	7.785	11.245	13.840	17.300	29.410	51.035	60.550	89.960
Stainless	[N]	4.275	6.413	9.263	11.400	14.250	24.225	42.038	49.875	74.100
<b>ALLOWABLE BELT FORCE / OPEN ENDED</b>										
Steel	[N]	1.403	2.104	3.040	3.741	4.676	7.950	13.795	16.367	24.317
Steel HF	[N]	1.296	1.944	2.808	3.456	4.320	7.344	12.744	15.120	22.464
Stainless	[N]	1.052	1.578	2.280	2.806	3.507	5.962	10.346	12.275	18.237
<b>ALLOWABLE BELT FORCE / ENDLESS WELDED</b>										
Steel	[N]	701	1.052	1.520	1.871	2.338	3.975	6.897	8.183	12.158
Steel HF	[N]	648	972	1.404	1.728	2.160	3.672	6.372	7.560	11.232
Stainless	[N]	526	798	1.140	1.403	1.754	2.981	5.173	6.138	9.119
<b>ALLOWABLE EFFECTIVE FORCE / MINIMUM 12 TEETH IN MESH</b>										
	[N]	920	1.380	1.840	2.300	2.760	4.600	7.820	9.200	13.800
<b>BELT WEIGHT</b>										
Steel	[kg/m]	0,05	0,08	0,10	0,13	0,15	0,25	0,42	0,50	0,75
Steel HF	[kg/m]	0,05	0,07	0,09	0,12	0,14	0,23	0,39	0,47	0,70
Stainless	[kg/m]	0,05	0,07	0,10	0,12	0,15	0,25	0,42	0,50	0,74
<b>SPECIFIC BELT STIFFNESS</b>										
Steel	[kg/m]	350.719	526.078	759.891	935.250	1.169.063	1.987.406	3.448.734	4.091.719	6.079.125
Steel HF	[kg/m]	324.000	486.000	702.000	864.000	1.080.000	1.836.000	3.186.000	3.780.000	5.616.000
Stainless	[kg/m]	263.039	394.559	569.918	701.438	876.797	1.490.555	2.586.551	3.068.789	4.559.344

**GPP8-RSL / PITCH: 8MM**

**PRODUCT SPECIFICATIONS**

<b>PITCH</b>	8 mm
<b>STANDARD THICKNESS</b>	5,4 mm
<b>WIDTH TOLERANCE</b>	+ -0,50 mm
<b>STANDARD ROLL LENGTH (TOLERANCE ±1%)</b>	100 m
<b>STANDARD COLOR</b>	White
<b>FDA/EU APPROVAL</b>	No
<b>POLYAMIDE FABRIC</b>	
STANDARD	NT
OPTIONAL	NTB

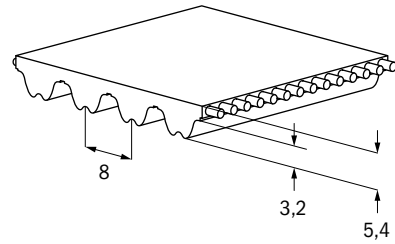

**PULLEY DEFINITION**

GPP8 BELT RUNS IN RPP8 AND HTD8M PULLEY PROFILE FOR HEAVY LIFTING AND HIGH DYNAMIC APPLICATION PLEASE CONTACT OUR APPLICATION ENGINEERS

**MIN PULLEY DIAMETER:**

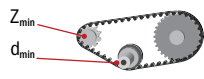
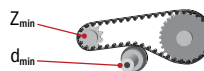
	STEEL	STEEL HF
 z min	32	25
d min	82	64
 z min	35	28
d min	150	130

POLYURETHANE	HARDNESS [°SHORE A]	TEMPERATURE RANGE [°C]	FEATURE
R1	92	-5 to +70	Standard
R23T	90	-30 to +50	Low Temperature

**TECHNICAL DATA**

STANDARD WIDTH (MM)	UNIT	15	20	25	30	50	85	100	150
<b>BREAKING FORCE / AVERAGE VALUE</b>									
Steel	[N]	13.840	19.030	25.950	31.140	51.900	91.690	103.800	155.700
Steel HF	[N]	15.400	21.175	28.875	34.650	57.750	102.025	115.500	173.250
<b>ALLOWABLE BELT FORCE / OPEN ENDED</b>									
Steel	[N]	3.349	4.604	6.279	7.534	12.557	22.184	25.114	37.671
Steel HF	[N]	2.902	3.991	5.442	6.530	10.884	19.228	21.767	32.651
<b>ALLOWABLE EFFECTIVE FORCE / MINIMUM 12 TEETH IN MESH</b>									
	[N]	1.380	1.840	2.300	2.760	4.600	7.820	9.200	13.800
<b>BELT WEIGHT</b>									
Steel	[kg/m]	0,11	0,15	0,18	0,22	0,37	0,63	0,72	1,09
Steel HF	[kg/m]	0,11	0,15	0,18	0,22	0,37	0,63	0,72	1,09
<b>SPECIFIC BELT STIFFNESS</b>									
Steel	[N]	837.143	1.151.071	1.569.643	1.883.571	3.139.286	5.546.071	6.278.571	9.417.857
Steel HF	[N]	725.571	997.661	1.360.446	1.632.536	2.720.893	4.806.911	5.441.786	8.162.679

**GPP14 / PITCH: 14MM****PRODUCT SPECIFICATIONS**

<b>PITCH</b>	14 mm
<b>STANDARD THICKNESS</b>	9,7 mm
<b>WIDTH TOLERANCE</b>	+1,00 mm
<b>MINIMUM WELDED BELT LENGTH</b>	N/A
<b>STANDARD ROLL LENGTH (TOLERANCE ±1%)</b>	50 m
<b>STANDARD COLOR</b>	White
<b>FDA/EU APPROVAL</b>	No
<b>POLYAMIDE FABRIC</b>	
STANDARD	NT
OPTIONAL	NTB

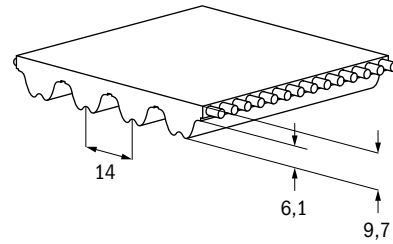
**PULLEY DEFINITION**

GPP14 BELT RUNS IN RPP14 AND HTD14M PULLEY PROFILES  
FOR HEAVY LIFTING AND HIGH DYNAMIC APPLICATION  
PLEASE CONTACT OUR APPLICATION ENGINEERS

**MIN PULLEY DIAMETER:**

		STEEL
	<b>z min</b>	32
	<b>d min</b>	143
	<b>z min</b>	32
	<b>d min</b>	200

POLYURETHANE	HARDNESS [° SHORE A]	TEMPERATURE RANGE [° C]	FEATURE
R1	92	-5 to +70	Standard
R23T	90	-30 to +50	Low Temperature

**TECHNICAL DATA**

STANDARD WIDTH (MM)	UNIT	40	55	85	115	150	170
<b>BREAKING FORCE / AVERAGE VALUE</b>							
Steel	[N]	64.600	87.400	136.800	186.200	247.000	273.600
<b>ALLOWABLE BELT FORCE / OPEN ENDED</b>							
Steel	[N]	17.850	24.150	37.800	51.450	68.250	75.600
<b>ALLOWABLE EFFECTIVE FORCE / MINIMUM 12 TEETH IN MESH</b>							
	[N]	6.900	9.488	14.663	19.838	25.875	29.325
<b>BELT WEIGHT</b>							
Steel	[kg/m]	0,50	0,69	1,07	1,44	1,88	2,13
<b>SPECIFIC BELT STIFFNESS</b>							
Steel	[N]	4.462.500	6.037.500	9.450.000	12.862.500	17.062.500	18.900.000

# GPP14-RSL / PITCH: 14MM

### PRODUCT SPECIFICATIONS

<b>PITCH</b>	14 mm
<b>STANDARD THICKNESS</b>	9,7 mm
<b>WIDTH TOLERANCE</b>	+1,00 mm
<b>MINIMUM WELDED BELT LENGTH</b>	N/A
<b>STANDARD ROLL LENGTH (TOLERANCE ±1%)</b>	50 m
<b>STANDARD COLOR</b>	White
<b>FDA/EU APPROVAL</b>	No
<b>POLYAMIDE FABRIC</b>	
STANDARD	NT
OPTIONAL	NTB

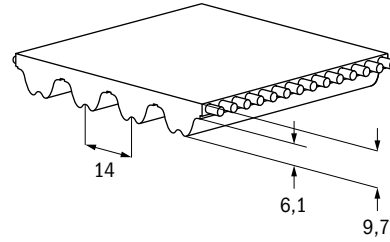

### PULLEY DEFINITION

GPP14-RSL BELT REQUIRES A SPECIAL PULLEY PROFILE  
PLEASE CONTACT OUR APPLICATION ENGINEERS

#### MIN PULLEY DIAMETER:

		STEEL
	<b>z min</b>	34
	<b>d min</b>	152
	<b>z min</b>	34
	<b>d min</b>	250

POLYURETHANE	HARDNESS [° SHORE A]	TEMPERATURE RANGE [° C]	FEATURE
R1	92	-5 to +70	Standard
R23T	90	-30 to +50	Low Temperature

### TECHNICAL DATA

STANDARD WIDTH (MM)	UNIT	40	55	85	115	150	200
<b>BREAKING FORCE / AVERAGE VALUE</b>							
Steel	[N]	82.500	112.500	180.000	247.500	322.500	427.500
<b>ALLOWABLE BELT FORCE / OPEN ENDED</b>							
Steel	[N]	19.621	26.756	42.810	58.864	76.701	101.674
<b>ALLOWABLE EFFECTIVE FORCE / MINIMUM 12 TEETH IN MESH</b>							
	[N]	6.900	9.488	14.663	19.838	25.875	29.325
<b>BELT WEIGHT</b>							
Steel	[kg/m]	0,56	0,76	1,18	1,60	2,08	2,78
<b>SPECIFIC BELT STIFFNESS</b>							
Steel	[N]	4.905.312	6.689.062	10.702.499	14.715.936	19.175.311	25.418.435

**XL / PITCH: 0,20" / 5,08MM****PRODUCT SPECIFICATIONS**

<b>PITCH</b>	0,200" / 5,08 mm
<b>STANDARD THICKNESS</b>	0,090" / 2,29 mm
<b>WIDTH TOLERANCE</b>	
< 2" / 50 MM WIDTH	+0,020" / +0,5 mm
> 2" / 50 MM WIDTH	+0,030" / +0,75 mm
<b>MINIMUM WELDED BELT LENGTH</b>	19,2" / 487,68 mm
<b>STANDARD ROLL LENGTH</b>	328 ft / 100 m
<b>STANDARD COLOR</b>	White
<b>FDA/EU APPROVAL</b>	Option
<b>POLYAMIDE FABRIC</b>	Optional NT, NB & NTB

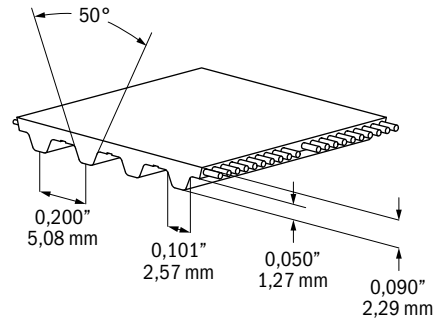
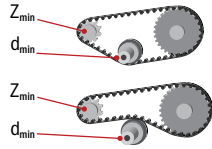
**MIN PULLEY DIAMETER:**

	STEEL	ARAMID
<b>z min</b>	10	10
<b>d min</b>	0,64" / 16,25 mm	0,64" / 16,25 mm
<b>z min</b>	15	15
<b>d min</b>	1,125" / 28,6 mm	1,125" / 28,6 mm

POLYURETHANE	HARDNESS [°SHORE A]	TEMPERATURE RANGE [°C]	FEATURE
R1	92	-5 to +70	Standard
R2	85	-10 to +60	
FDA	85	-10 to +60	With Aramid Cord Only

**TECHNICAL DATA**

STANDARD WIDTH ("/MM)	UNIT	0,25"/6,35MM	0,31"/7,874MM	0,38"/9,65MM	0,50"/12,7MM	0,75"/19,05MM	1"/25,4MM	2"/50,8MM	4"/101,6MM
<b>BREAKING FORCE / AVERAGE VALUE</b>									
Steel	[N]	750	875	1.125	1.625	2.500	3.375	6.875	13.875
Aramid	[N]	976	1.238	1.525	2.074	3.172	4.270	8.662	17.446
<b>ALLOWABLE BELT FORCE / OPEN ENDED</b>									
Steel	[N]	190	221	284	411	632	853	1.738	3.509
Aramid	[N]	213	270	332	452	691	930	1.887	3.800
<b>ALLOWABLE BELT FORCE / ENDLESS WELDED</b>									
Steel	[N]	95	111	142	205	316	427	869	1.754
Aramid	[N]	159	202	249	339	518	698	1.415	2.850
<b>ALLOWABLE EFFECTIVE FORCE / MINIMUM 12 TEETH IN MESH</b>									
	[N]	157	194	235	314	470	627	1.254	2.508
<b>BELT WEIGHT</b>									
Steel	[kg/m]	0,01	0,02	0,02	0,03	0,04	0,06	0,11	0,22
Aramid	[kg/m]	0,01	0,01	0,02	0,02	0,04	0,05	0,10	0,19
<b>SPECIFIC BELT STIFFNESS</b>									
Steel	[N]	47.413	55.316	71.120	102.729	158.044	213.360	434.622	877.147
Aramid	[N]	53.151	67.436	83.049	112.947	172.742	232.537	471.718	950.080

**L / PITCH: 0,375" / 9,525MM**

**PRODUCT SPECIFICATIONS**

<b>PITCH</b>	0,375" / 9,525 mm
<b>STANDARD THICKNESS</b>	0,140" / 3,56 mm
<b>WIDTH TOLERANCE</b>	
< 2" / 50 MM WIDTH	+,-0,020" / +,-0,5 mm
> 2" / 50 MM WIDTH	+,-0,030" / +,-0,75 mm
<b>MINIMUM WELDED BELT LENGTH</b>	19,2" / 487,68 mm
<b>STANDARD ROLL LENGTH</b>	328 ft / 100 m
<b>STANDARD COLOR</b>	Clear, Optional White
<b>FDA/EU APPROVAL</b>	Option
<b>POLYAMIDE FABRIC</b>	Optional NT, NB & NTB

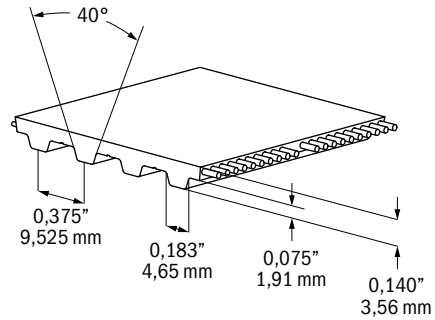

**MIN PULLEY DIAMETER:**

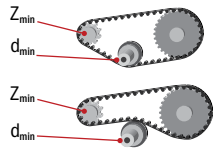

	STEEL	ARAMID
<b>z min</b>	10	10
<b>d min</b>	1,19" / 30,25 mm	1,19" / 30,25 mm
<b>z min</b>	14	14
<b>d min</b>	2,375" / 60,3 mm	2,375" / 60,3 mm

POLYURETHANE	HARDNESS [° SHORE A]	TEMPERATURE RANGE [° C]	FEATURE
R1	92	-5 to +70	Standard
R2	85	-10 to +60	
FDA	85	-10 to +60	With Aramid Cord Only

**TECHNICAL DATA**

STANDARD WIDTH ("/MM)	UNIT	0,38"/9,65MM	0,50"/12,7MM	0,75"/19,05MM	1"/25,4MM	1,5"/38,1MM	2"/50,8MM	4"/101,6MM
<b>BREAKING FORCE / AVERAGE VALUE</b>								
Steel	[N]	2.280	3.135	4.845	6.555	9.975	13.395	27.075
Aramid	[N]	2.672	3.674	5.678	7.682	11.690	15.698	31.730
<b>ALLOWABLE BELT FORCE / OPEN ENDED</b>								
Steel	[N]	574	790	1.221	1.652	2.513	3.375	6.821
Aramid	[N]	428	588	909	1.229	1.871	2.512	5.078
<b>ALLOWABLE BELT FORCE / ENDLESS WELDED</b>								
Steel	[N]	287	395	610	826	1.257	1.687	3.411
Aramid	[N]	321	441	681	922	1.403	1.884	3.808
<b>ALLOWABLE EFFECTIVE FORCE / MINIMUM 12 TEETH IN MESH</b>								
	[N]	505	674	1.010	1.347	2.021	2.694	5.388
<b>BELT WEIGHT</b>								
Steel	[kg/m]	0,03	0,04	0,06	0,08	0,11	0,15	0,30
Aramid	[kg/m]	0,03	0,04	0,06	0,08	0,11	0,15	0,30
<b>SPECIFIC BELT STIFFNESS</b>								
Steel	[N]	143.609	197.463	305.170	412.877	628.291	843.705	1.705.362
Aramid	[N]	106.901	146.989	227.164	307.340	467.691	628.043	1.269.448



**H / PITCH: 0,50" / 12,7MM****PRODUCT SPECIFICATIONS**

<b>PITCH</b>	0,500" / 12,7mm
<b>STANDARD THICKNESS</b>	0,16" / 4,06 mm
<b>WIDTH TOLERANCE</b>	
< 2" / 50 MM WIDTH	+0,020" / +0,5 mm
> 2" / 50 MM WIDTH	+0,030" / +0,75 mm
<b>MINIMUM WELDED BELT LENGTH</b>	
< 4" / 100MM WIDTH	19,125" / 482,6 mm
> 4" / 100MM WIDTH	38" / 965,2 mm
<b>STANDARD ROLL LENGTH</b>	328 ft / 100 m
<b>STANDARD COLOR</b>	White
<b>FDA/EU APPROVAL</b>	Option
<b>POLYAMIDE FABRIC</b>	Optional NT, NB & NTB

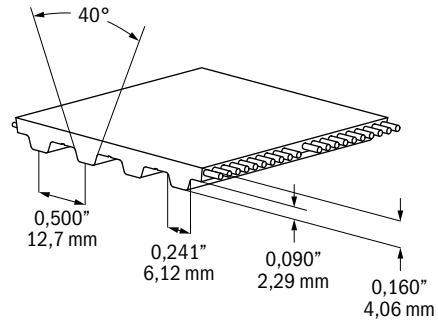
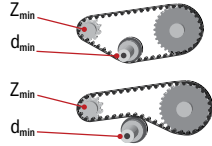
**MIN PULLEY DIAMETER:**

	STEEL	ARAMID	STEEL HF
<b>z min</b>	14	14	12
<b>d min</b>	2,23" / 56,6 mm	2,23" / 56,6 mm	1,91" / 48,5 mm
<b>z min</b>	20	20	15
<b>d min</b>	3,15" / 80 mm	3,15" / 80 mm	2,36" / 60 mm

POLYURETHANE	HARDNESS [° SHORE A]	TEMPERATURE RANGE [° C]	FEATURE
R1	92	-5 to +70	Standard
R2	85	-10 to +60	
FDA	85	-10 to +60	With Aramid Cord Only

**TECHNICAL DATA**

STANDARD WIDTH ("/MM)	UNIT	0,50" / 12,7MM	0,75" / 19,05MM	1" / 25,4MM	1,5" / 38,1MM	2" / 50,8MM	3" / 76,2MM	4" / 101,6MM	6" / 152,4MM
<b>BREAKING FORCE / AVERAGE VALUE</b>									
Steel	[N]	3.360	5.040	7.140	10.920	14.700	22.260	29.820	44.940
Aramid	[N]	3.773	5.929	8.085	12.397	16.709	25.333	33.957	51.205
Steel HF	[N]	4.960	7.440	10.540	16.120	21.700	32.860	44.020	66.340
<b>ALLOWABLE BELT FORCE / OPEN ENDED</b>									
Steel	[N]	912	1.369	1.939	2.966	3.992	6.045	8.098	12.205
Aramid	[N]	504	792	1.081	1.657	2.233	3.386	4.538	6.843
Steel HF	[N]	1.119	1.678	2.377	3.636	4.895	7.412	9.929	14.964
<b>ALLOWABLE BELT FORCE / ENDLESS WELDED</b>									
Steel	[N]	456	684	970	1.483	1.996	3.023	4.049	6.102
Aramid	[N]	378	594	810	1.243	1.675	2.539	3.404	5.132
Steel HF	[N]	559	839	1.189	1.818	2.447	3.706	4.965	7.482
<b>ALLOWABLE EFFECTIVE FORCE / MINIMUM 12 TEETH IN MESH</b>									
	[N]	825	1.238	1.650	2.475	3.300	4.950	6.600	9.900
<b>BELT WEIGHT</b>									
Steel	[kg/m]	0,05	0,08	0,10	0,15	0,20	0,30	0,40	0,61
Aramid	[kg/m]	0,04	0,06	0,08	0,12	0,16	0,24	0,33	0,49
Steel HF	[kg/m]	0,05	0,08	0,11	0,16	0,22	0,33	0,44	0,66
<b>SPECIFIC BELT STIFFNESS</b>									
Steel	[N]	228.122	342.183	484.759	741.396	998.033	1.511.307	2.024.582	3.051.130
Aramid	[N]	126.060	198.095	270.129	414.198	558.267	846.404	1.134.542	1.710.817
Steel HF	[N]	279.699	419.548	594.360	909.021	1.223.682	1.853.005	2.482.327	3.740.972

**XH / PITCH: 0,875" / 22,225MM**

**PRODUCT SPECIFICATIONS**

<b>PITCH</b>	0,875" / 22,225 mm
<b>STANDARD THICKNESS</b>	0,440" / 11,18 mm
<b>WIDTH TOLERANCE</b>	+0,040" / +-1,00 mm
<b>MINIMUM WELDED BELT LENGTH</b>	30,4" / 1000,76 mm
<b>STANDARD ROLL LENGTH (TOLERANCE ±1%)</b>	50 m
<b>STANDARD COLOR</b>	White
<b>FDA/EU APPROVAL</b>	Option
<b>POLYAMIDE FABRIC</b>	Optional NT, NB & NTB

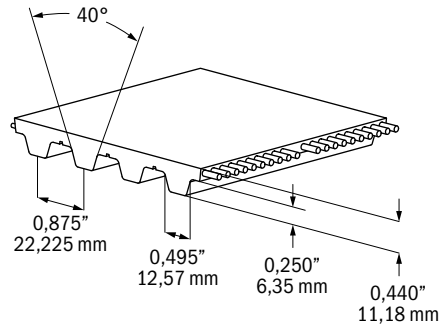

**MIN PULLEY DIAMETER:**

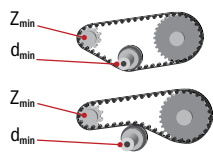

	STEEL	ARAMID
<b>z min</b>	18	18
<b>d min</b>	5,01" / 127,75 mm	5,01" / 127,75 mm
<b>z min</b>	20	20
<b>d min</b>	5,875" / 149,2 mm	5,875" / 149,2 mm

POLYURETHANE	HARDNESS [° SHORE A]	TEMPERATURE RANGE [°C]	FEATURE
R1	92	-5 to +70	Standard
R2	85	-10 to +60	
FDA	85	-10 to +60	With Aramid Cord Only

**TECHNICAL DATA**

STANDARD WIDTH ("/MM)	UNIT	1"/25,4MM	1,5"/38,1MM	2"/50,8MM	3"/76,2MM	4"/101,6MM	6"/152,4MM
<b>BREAKING FORCE / AVERAGE VALUE</b>							
Steel	[N]	14.250	21.850	29.450	44.650	59.850	90.250
Aramid	[N]	16.185	24.817	33.449	50.713	67.977	102.505
<b>ALLOWABLE BELT FORCE / OPEN ENDED</b>							
Steel	[N]	3.801	5.828	7.855	11.909	15.964	24.072
Aramid	[N]	1.778	2.726	3.675	5.571	7.468	11.261
<b>ALLOWABLE BELT FORCE / ENDLESS WELDED</b>							
Steel	[N]	1.900	2.914	3.928	5.955	7.982	12.036
Aramid	[N]	1.134	2.045	2.756	4.178	5.601	8.446
<b>ALLOWABLE EFFECTIVE FORCE / MINIMUM 12 TEETH IN MESH</b>							
	[N]	3.285	4.928	6.570	9.855	13.140	19.710
<b>BELT WEIGHT</b>							
Steel	[kg/m]	0,27	0,40	0,54	0,81	1,08	1,62
Aramid	[kg/m]	0,23	0,35	0,46	0,69	0,92	1,39
<b>SPECIFIC BELT STIFFNESS</b>							
Steel	[N]	950.214	1.456.995	1.963.776	2.977.337	3.990.899	6.018.022
Aramid	[N]	444.500	681.567	918.633	1.392.767	1.866.900	2.815.167



# E-BELT

## GATES TPU E-BELT TRANSMIT ELECTRICAL POWER AND SIGNALS

Gates TPU e-belts are Synchro-Power Linear belts that can transmit electric power or signals while incorporating the high tensile strength of the steel reinforcement. The steel cords are exposed at the belt ends for electrical connector attachment. The open-ended e-Belts can be cut to custom length. Several timing belt pitches and flat belts are available.

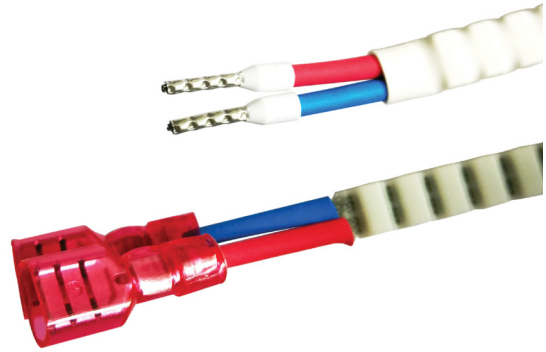

### PRODUCT SPECIFICATIONS

<b>PITCH</b>	T5 / T10 / T20 / AT5 / ATL5 / AT10 / ATL10 / F20 / WR5 / WRT10 / WRAT10
<b>CORD</b>	Steel, Steel HF, Stainless Steel
<b>COLOR</b>	White, F20 Black
<b>FDA/EU APPROVAL</b>	No
<b>POLYURETHANE</b>	92° Shore A
<b>POLYAMIDE FABRIC</b>	N/A
<b>TEMPERATURE RANGE</b>	-5 °C to +60 °C
<b>MAXIMUM VOLTAGE</b>	24V DC
<b>MAXIMUM ELECTRICAL POWER</b>	Depending on cord construction
<b>OTHER TECHNICAL DATA</b>	Depending on belt construction

### FEATURES + BENEFITS

- Belt with exposed steel cords
- Optional applied connectors
- Synchronous belt pitches or flat belt
- Electric power transmission up to 24V DC
- Maximum power depends upon steel cord construction
- Electrical signal transmission
- Steel reinforcement options for a wide range of applications
- Available within WR Belt series with fully encapsulated cord
- EU, RoHS, and REACH compliant
- Engineering support for custom designs

Gates e-Belts supply limited electric power to small motors or actuators and can transmit electrical signals. The maximum power is determined by the construction and the number of steel cords used for the electrical transmission. Gates TPU delivers customized solutions with your specified connectors applied to the belt.

## USING GATES E-BELT CAN SAVE COST AND SPACE FOR SEPARATE ELECTRICAL CABLES AND CABLE GUIDING SYSTEMS

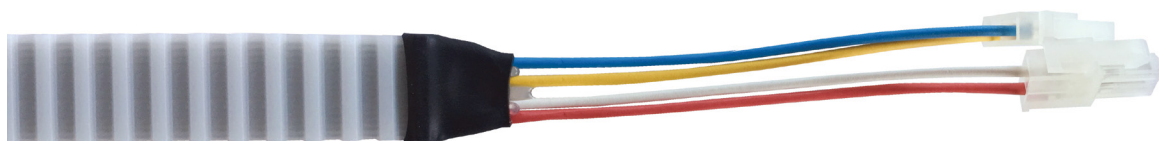



# WR – WATER RESISTANT BELTS

## LINEAR WR

Gates Synchro-Power Linear WR series belts are designed for applications in highly corrosive environments and/or for the requirements in applications with direct food contact and the related cleaning processes.

The fully encapsulated cord is not exposed to the environment, prevents hidden contaminations and is easy to clean.

Extruded with wear resistant polyurethane the belt can be equipped with steel or Aramid cord. Various cord options offer fit for purpose tensile strength and stiffness at small pulley diameters.

Backings and profiles suitable for food contact are available for customized conveying and transportation solutions.

**SYNCHRO-POWER LINEAR WR SERIES BELTS ARE COMMONLY USED AS ENDLESS WELDED BELT IN CONVEYING AND PROCESSING APPLICATIONS OR IN HIGHLY CORROSIVE ENVIRONMENTS.**

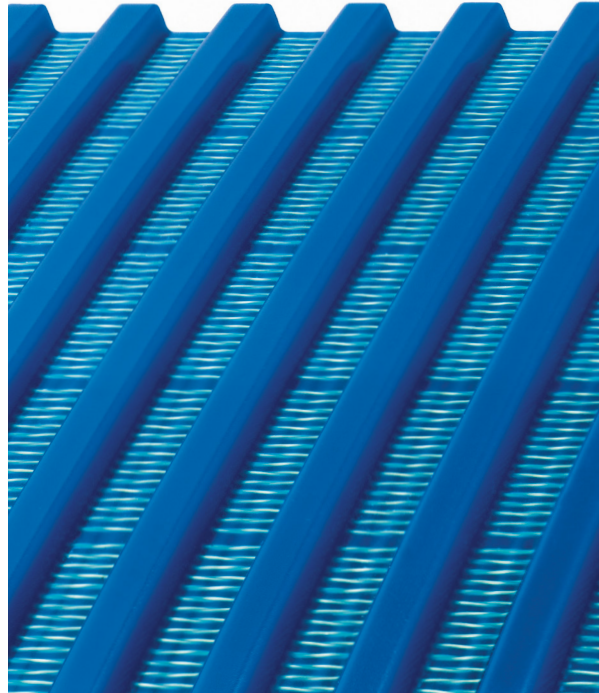

### ATTRIBUTES

- Fully encapsulated cord
- Excellent resistance to chemicals and corrosion
- Steel or Aramid reinforcement
- Certified for wet and dry food contact
- Meets FDA and EU food regulations
- High level of hygienic integrity, easy to clean

### APPLICATIONS

- In corrosive environments: outdoor equipment, sunshades, chemical industry
- Food conveying applications

# WR5 / PITCH: 5MM

**PRODUCT SPECIFICATIONS**

<b>PITCH</b>	5 mm
<b>STANDARD THICKNESS</b>	2,7 mm
<b>WIDTH TOLERANCE</b>	
< 50MM WIDTH	+ -0,50 mm
> 50MM WIDTH	+ -0,75 mm
<b>MINIMUM WELDED BELT LENGTH</b>	500 mm
<b>STANDARD ROLL LENGTH (TOLERANCE ±1%)</b>	100 m
<b>STANDARD COLOR</b>	Blue, optional White
<b>FDA/EU APPROVAL</b>	Option
<b>POLYAMIDE FABRIC</b>	No

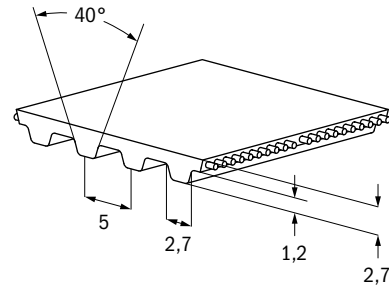

**MIN PULLEY DIAMETER:**

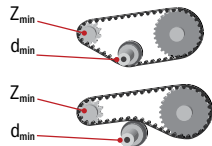

	STEEL	ARAMID
<b>z min</b>	10	10
<b>d min</b>	30	30
<b>z min</b>	15	15
<b>d min</b>	30	30

POLYURETHANE	HARDNESS [ 'SHORE A ]	TEMPERATURE RANGE [ °C ]	FEATURE
R1	92	-5 to +70	Standard
FDA	85	-10 to +60	With Aramid Cord Only

**TECHNICAL DATA**

STANDARD WIDTH (MM)	UNIT	10	16	25	32	50	75	100
<b>BREAKING FORCE / AVERAGE VALUE</b>								
Steel	[N]	1.250	2.000	3.375	4.250	6.875	10.375	13.875
Aramid	[N]	3.162	5.245	8.670	10.800	17.050	25.730	34.410
<b>ALLOWABLE BELT FORCE / OPEN ENDED</b>								
Steel	[N]	311	498	840	1.058	1.711	2.582	3.453
Aramid	[N]	346	574	916	1.181	1.865	2.814	3.764
<b>ALLOWABLE BELT FORCE / ENDLESS WELDED</b>								
Steel	[N]	156	249	420	529	856	1.291	1.727
Aramid	[N]	259	430	687	886	1.399	2.111	2.823
<b>ALLOWABLE EFFECTIVE FORCE / MINIMUM 12 TEETH IN MESH</b>								
	[N]	250	400	625	800	1.250	1.875	2.500
<b>BELT WEIGHT</b>								
Steel	[kg/m]	0,02	0,04	0,06	0,07	0,11	0,17	0,22
Aramid	[kg/m]	0,02	0,03	0,05	0,06	0,10	0,15	0,20
<b>SPECIFIC BELT STIFFNESS</b>								
Steel	[N]	77.778	124.444	210.000	264.444	427.778	645.556	863.333
Aramid	[N]	86.464	143.428	228.875	295.334	466.227	703.579	940.931

**WRT10 / PITCH: 10MM**

**PRODUCT SPECIFICATIONS**

<b>PITCH</b>	10 mm
<b>STANDARD THICKNESS</b>	4,5 mm
<b>WIDTH TOLERANCE</b>	
< 50MM WIDTH	+/-0,50 mm
> 50MM WIDTH	+/-0,75 mm
<b>MINIMUM WELDED BELT LENGTH</b>	
< 100MM WIDTH	500 mm
> 100MM WIDTH	960 mm
<b>STANDARD ROLL LENGTH (TOLERANCE ±1%)</b>	100 m
<b>STANDARD COLOR</b>	Standard Blue, optional White
<b>FDA/EU APPROVAL</b>	Option
<b>POLYAMIDE FABRIC</b>	No

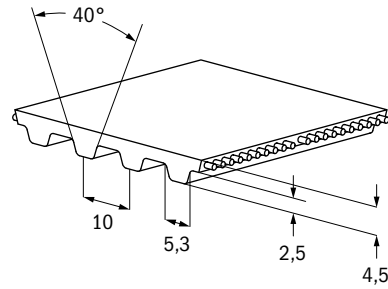

**MIN PULLEY DIAMETER:**

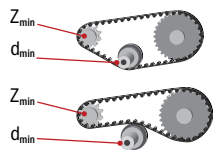

	STEEL	ARAMID	STEEL HF
<b>z min</b>	14	14	12
<b>d min</b>	45	45	38
<b>z min</b>	18	18	15
<b>d min</b>	80	80	60

POLYURETHANE	HARDNESS [° SHORE A]	TEMPERATURE RANGE [° C]	FEATURE
R1	92	-5 to +70	Standard
FDA	85	-10 to +60	With Aramid Cord Only

**TECHNICAL DATA**

STANDARD WIDTH (MM)	UNIT	12	16	25	32	50	75	100	150
<b>BREAKING FORCE / AVERAGE VALUE</b>									
Steel	[N]	2.940	4.200	7.140	9.240	14.700	22.260	29.820	44.940
Aramid	[N]	3.601	4.980	8.085	10.500	16.709	25.333	33.957	51.205
Steel HF	[N]	4.340	6.200	10.540	13.640	21.700	32.860	44.020	66.340
<b>ALLOWABLE BELT FORCE / OPEN ENDED</b>									
Steel	[N]	786	1.123	1.909	2.470	3.929	5.950	7.971	12.012
Aramid	[N]	474	655	1.064	1.381	2.198	3.332	4.467	6.736
Steel HF	[N]	964	1.376	2.340	3.028	4.818	7.295	9.773	14.728
<b>ALLOWABLE BELT FORCE / ENDLESS WELDED</b>									
Steel	[N]	393	561	954	1.235	1.965	2.975	3.985	6.006
Aramid	[N]	355	491	798	1.036	1.648	2.499	3.350	5.052
Steel HF	[N]	482	688	1.170	1.214	2.409	3.648	4.886	7.364
<b>ALLOWABLE EFFECTIVE FORCE / MINIMUM 12 TEETH IN MESH</b>									
	[N]	683	910	1.423	1.821	2.845	4.268	5.690	8.535
<b>BELT WEIGHT</b>									
Steel	[kg/m]	0,05	0,06	0,09	0,11	0,18	0,27	0,36	0,54
Aramid	[kg/m]	0,04	0,06	0,09	0,11	0,18	0,27	0,36	0,54
Steel HF	[kg/m]	0,05	0,07	0,11	0,15	0,23	0,35	0,47	0,70
<b>SPECIFIC BELT STIFFNESS</b>									
Steel	[N]	196.463	280.662	477.125	617.456	982.316	1.487.507	1.992.699	3.003.081
Aramid	[N]	118.403	163.779	265.875	345.283	549.475	833.075	1.116.675	1.683.875
Steel HF	[N]	240.882	344.118	585.000	757.059	1.204.412	1.823.824	3.443.235	3.682.059

**WRAT10 / PITCH: 10MM****PRODUCT SPECIFICATIONS**

<b>PITCH</b>	10 mm
<b>STANDARD THICKNESS</b>	4,5 mm
<b>WIDTH TOLERANCE</b>	
< 50MM WIDTH	+ -0,75 mm
> 50MM WIDTH	+ -1,00 mm
<b>MINIMUM WELDED BELT LENGTH</b>	
< 100MM WIDTH	500 mm
> 100MM WIDTH	960 mm
<b>STANDARD ROLL LENGTH</b>	100 m
<b>STANDARD COLOR</b>	Standard Blue, optional White
<b>FDA/EU APPROVAL</b>	Option
<b>POLYAMIDE FABRIC</b>	No

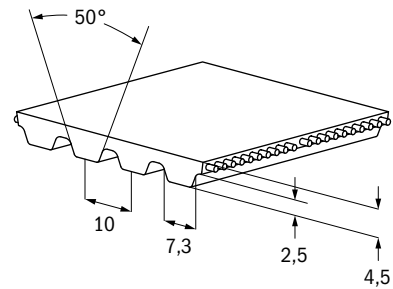
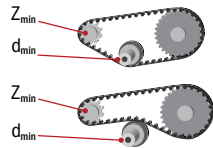
**MIN PULLEY DIAMETER:**

	STEEL	ARAMID
<b>z min</b>	15	15
<b>d min</b>	50	50
<b>z min</b>	25	25
<b>d min</b>	120	120

POLYURETHANE	HARDNESS [°SHORE A]	TEMPERATURE RANGE [°C]	FEATURE
R1	92	-5 to +70	Standard
FDA	85	-10 to +60	With Aramid Cord Only

**TECHNICAL DATA**

STANDARD WIDTH (MM)	UNIT	16	25	32	50	75	100	150
<b>BREAKING FORCE / AVERAGE VALUE</b>								
Steel	[N]	8.550	14.250	18.050	29.450	44.650	59.850	90.250
Aramid	[N]	9.970	16.185	21.019	33.449	50.713	67.977	102.505
<b>ALLOWABLE BELT FORCE / OPEN ENDED</b>								
Steel	[N]	2.245	3.741	4.739	7.731	11.722	15.712	23.693
Aramid	[N]	1.078	1.750	2.273	3.617	5.483	7.350	11.083
<b>ALLOWABLE BELT FORCE / ENDLESS WELDED</b>								
Steel	[N]	1.122	1.871	2.369	3.866	5.861	7.856	11.847
Aramid	[N]	809	1.313	1.705	2.713	4.113	5.513	8.313
<b>ALLOWABLE EFFECTIVE FORCE / MINIMUM 12 TEETH IN MESH</b>								
	[N]	1.651	2.580	3.302	5.160	7.740	10.320	15.480
<b>BELT WEIGHT</b>								
Steel	[kg/m]	0,09	0,14	0,18	0,29	0,43	0,57	0,86
Aramid	[kg/m]	0,07	0,11	0,13	0,21	0,32	0,42	0,63
<b>SPECIFIC BELT STIFFNESS</b>								
Steel	[N]	561.150	935.250	1.184.650	1.932.850	2.930.450	3.928.050	5.923.250
Aramid	[N]	269.500	437.500	568.167	904.167	1.370.833	1.837.500	2.770.833



**WRATL20 / PITCH: 20MM****PRODUCT SPECIFICATIONS**

<b>PITCH</b>	20 mm
<b>STANDARD THICKNESS</b>	8,0 mm
<b>WIDTH TOLERANCE</b>	+2,0 mm
<b>MINIMUM WELDED BELT LENGTH</b>	N/A
<b>STANDARD ROLL LENGTH (TOLERANCE ±1%)</b>	50 m
<b>STANDARD COLOR</b>	White
<b>FDA/EU APPROVAL</b>	No
<b>POLYAMIDE FABRIC</b>	No

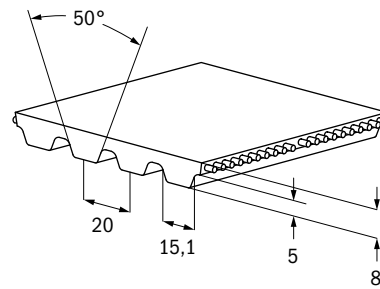
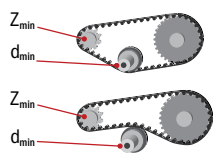
**MIN PULLEY DIAMETER:**

	STEEL
<b>z min</b>	25
<b>d min</b>	190
<b>z min</b>	25
<b>d min</b>	250

POLYURETHANE	HARDNESS [° SHORE A]	TEMPERATURE RANGE [° C]	FEATURE
R1	92	-5 to +70	Standard

**TECHNICAL DATA**

STANDARD WIDTH (MM)	UNIT	50	75	100	150	155
<b>BREAKING FORCE / AVERAGE VALUE</b>						
Steel	[N]	70.400	105.600	144.000	217.600	224.000
<b>ALLOWABLE BELT FORCE / OPEN ENDED</b>						
Steel	[N]	15.410	23.115	31.520	47.631	49.032
<b>ALLOWABLE EFFECTIVE FORCE / MINIMUM 12 TEETH IN MESH</b>						
	[N]	10.900	16.350	21.800	32.700	33.790
<b>BELT WEIGHT</b>						
Steel	[kg/m]	0,54	0,81	1,08	1,63	1,68
<b>SPECIFIC BELT STIFFNESS</b>						
Steel	[N]	3.852.500	5.778.749	7.880.113	11.907.726	12.257.953



# GATES TPU SYNCHRO-CLEAN

## MODERN GATES TECHNOLOGY SOLVES FOOD PROCESSING CHALLENGES

With decades of experience developing synchronous timing belt systems, Gates TPU Food Belting is the next generation for food processing belts.

- Embedded tension cords virtually eliminate stretch
- Robust pin splice speeds belt fastening and removal
- Special extrusion process improves cleanability and limits contamination areas
- Split-tooth weld delivers greater strength

Gates TPU Food Belting is high-performance, high-quality, easy-to-clean, and allows customisation options to meet your specific food processing needs.



### FDA APPROVED

Meets material requirements for wet food contact.

### EU COMPLIANT

Meets material requirements for wet food contact.

### USDA ACCEPTED

For meat, poultry and dairy processing equipment.



GATES TPU TOOK ADVANTAGE OF ITS 30 YEARS OF TENSIONED TIMING BELTS TO REDESIGN THE “BLUE BELT” BY ADDING KEVLAR TENSION MEMBERS.

### ADVANTAGES

- Prevents stretch under load
- Prevents continuation of accidental belt cut
- Belt can be run tensioned or un-tensioned

### BENEFITS

- Ease of cleaning and reduced risk of food contamination
- Able to clean-in-place (CIP)
- Water, cleaning labor and waste water savings
- 35%, 54% and 35% respectively when compared to plastic modular belt



ASK FOR THE GATES TPU SYNCHRO-CLEAN CATALOG.



# SELF-TRACKING BELTS

## TRACKING BELTS

Gates TPU Self Tracking Belts are composed of our standard polyurethane belts and our specially designed polyurethane V-Guides, which provide highest flexibility and allow the use of small pulley diameters. Self-tracking belts can be manufactured in two different production processes depending on your need:

- **FABRICATED V-GUIDES ARE APPLIED TO STANDARD BELT VIA A SECONDARY OPERATION AND CAN BE COMBINED WITH ANY BELT TYPE AND BELT WIDTH.**
- **INTEGRAL V-GUIDES ARE INTEGRATED BY CO-EXTRUSION IN THE BELT PRODUCTION PROCESS AND ENSURE HIGHER STRENGTH AND CONSISTENCY.**



### ATTRIBUTES

- V-Guides can be added to nearly every belt type
- Synchronous operations
- Operation without flanged pulleys possible
- Reliable tracking which is not affected by lateral forces
- Reduction of lateral movement

### APPLICATIONS

- Where lateral forces apply and pulleys with flanges cannot be used
- Long length conveying or linear / rotary positioning, where tracking is an issue
- Conveying applications where design considerations prevent the use of pulley flanges

### PROCESSING OPTIONS

- Backings Further information on page 96
- Profiles Further information on page 102
- Special processing Further information on page 108

**FOR METRIC TOOTH PITCH BELTS**

K6-SECTION	K10-SECTION	K13-SECTION
<b>BELT DIMENSIONS</b>		
<b>PULLEY DIMENSIONS</b>		
<b>SLIDER BED DIMENSIONS</b>		

**FOR IMPERIAL TOOTH PITCH BELTS**

O-SECTION	A-SECTION
<b>BELT DIMENSIONS</b>	
<b>PULLEY DIMENSIONS</b>	
<b>SLIDER BED DIMENSIONS</b>	

# T5V / PITCH: 5MM

## PRODUCT SPECIFICATIONS

<b>PITCH</b>	5 mm
<b>INTEGRATED V-GUIDE</b>	K6
<b>WIDTH TOLERANCE</b>	
< 50MM WIDTH	+/-0,50 mm
> 50MM WIDTH	+/-0,75 mm
<b>MINIMUM WELDED BELT LENGTH</b>	960 mm
<b>STANDARD ROLL LENGTH (TOLERANCE ±1%)</b>	100 m
<b>STANDARD COLOR</b>	White
<b>FDA/EU APPROVAL</b>	Option
<b>POLYAMIDE FABRIC</b>	Optional NT, NB & NTB

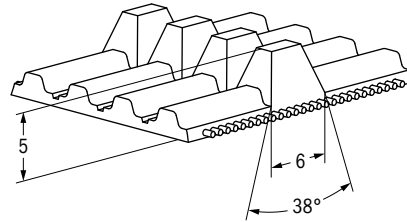

### MIN PULLEY DIAMETER:

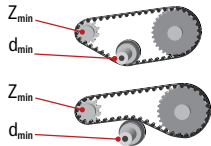

	STEEL	ARAMID
<b>z min</b>	25	25
<b>d min</b>	60	60
<b>z min</b>	28	28
<b>d min</b>	80	80

POLYURETHANE	HARDNESS [°SHORE A]	TEMPERATURE RANGE [°C]	FEATURE
R1	92	-5 to +70	Standard
R2	85	-10 to +60	
FDA	85	-10 to +60	With Aramid Cord Only

## TECHNICAL DATA

STANDARD WIDTH (MM)	UNIT	16	25	32	50	75	100
<b>BREAKING FORCE / AVERAGE VALUE</b>							
Steel	[N]	2.000	3.375	4.250	6.875	10.375	13.875
Aramid	[N]	4.960	8.370	10.800	17.050	25.730	34.410
<b>ALLOWABLE BELT FORCE / OPEN ENDED</b>							
Steel	[N]	498	840	1.058	1.711	2.582	3.453
Aramid	[N]	543	916	1.181	1.865	2.814	3.764
<b>ALLOWABLE BELT FORCE / ENDLESS WELDED</b>							
Steel	[N]	249	420	529	856	1.291	1.727
Aramid	[N]	407	687	886	1.399	2.111	2.823
<b>ALLOWABLE EFFECTIVE FORCE / MINIMUM 12 TEETH IN MESH</b>							
	[N]	250	475	650	1.100	1.725	2.350
<b>BELT WEIGHT</b>							
Steel	[kg/m]	0,07	0,08	0,09	0,13	0,19	0,24
Aramid	[kg/m]	0,06	0,07	0,08	0,12	0,17	0,22
<b>SPECIFIC BELT STIFFNESS</b>							
Steel	[N]	124.444	210.000	264.444	427.778	645.556	863.333
Aramid	[N]	135.630	228.875	295.334	466.227	703.579	940.931

**T10VS / PITCH: 10MM****PRODUCT SPECIFICATIONS**

<b>PITCH</b>	10 mm
<b>INTEGRATED V-GUIDE</b>	K6
<b>WIDTH TOLERANCE</b>	
< 50MM WIDTH	+ -0,50 mm
> 50MM WIDTH	+ -0,75 mm
<b>MINIMUM WELDED BELT LENGTH</b>	960 mm
<b>STANDARD ROLL LENGTH (TOLERANCE ±1%)</b>	100 m
<b>STANDARD COLOR</b>	White
<b>FDA/EU APPROVAL</b>	Option
<b>POLYAMIDE FABRIC</b>	Optional NT, NB & NTB

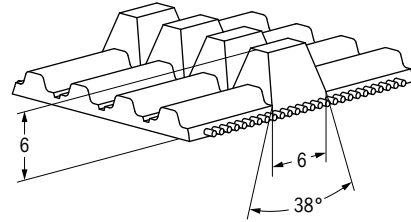
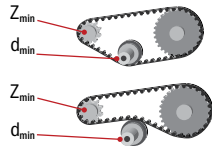
**MIN PULLEY DIAMETER:**

	STEEL	ARAMID
<b>z min</b>	20	20
<b>d min</b>	60	60
<b>z min</b>	25	25
<b>d min</b>	80	80

POLYURETHANE	HARDNESS [° SHORE A]	TEMPERATURE RANGE [° C]	FEATURE
R1	92	-5 to +70	Standard
R2	85	-10 to +60	
FDA	85	-10 to +60	With Aramid Cord Only

**TECHNICAL DATA**

STANDARD WIDTH (MM)	UNIT	16	25	32	50	75	100	150
<b>BREAKING FORCE / AVERAGE VALUE</b>								
Steel	[N]	4.200	7.140	9.240	14.700	22.260	29.820	44.940
Aramid	[N]	5.670	9.163	11.880	18.865	28.567	38.269	57.673
<b>ALLOWABLE BELT FORCE / OPEN ENDED</b>								
Steel	[N]	1.123	1.909	2.470	3.929	5.950	7.971	12.012
Aramid	[N]	658	1.064	1.379	2.190	3.316	4.442	6.694
<b>ALLOWABLE BELT FORCE / ENDLESS WELDED</b>								
Steel	[N]	561	954	1.235	1.965	2.975	3.985	6.006
Aramid	[N]	494	798	1.034	1.642	2.487	3.331	5.020
<b>ALLOWABLE EFFECTIVE FORCE / MINIMUM 12 TEETH IN MESH</b>								
	[N]	569	1.081	1.479	2.504	3.926	5.349	8.194
<b>BELT WEIGHT</b>								
Steel	[kg/m]	0,09	0,13	0,16	0,24	0,35	0,46	0,67
Aramid	[kg/m]	0,06	0,11	0,13	0,20	0,27	0,36	0,54
<b>SPECIFIC BELT STIFFNESS</b>								
Steel	[N]	280.662	477.125	617.456	982.316	1.487.507	1.992.699	3.003.081
Aramid	[N]	164.530	265.875	344.699	547.390	828.904	1.110.419	1.673.449

# T10V / PITCH: 10MM

## PRODUCT SPECIFICATIONS

<b>PITCH</b>	10 mm
<b>INTEGRATED V-GUIDE</b>	K13
<b>WIDTH TOLERANCE</b>	
< 50MM WIDTH	+/-0,50 mm
> 50MM WIDTH	+/-0,75 mm
<b>MINIMUM WELDED BELT LENGTH</b>	960 mm
<b>STANDARD ROLL LENGTH (TOLERANCE ±1%)</b>	50m Optional 100m
<b>STANDARD COLOR</b>	White
<b>FDA/EU APPROVAL</b>	Option
<b>POLYAMIDE FABRIC</b>	Optional NT, NB & NTB

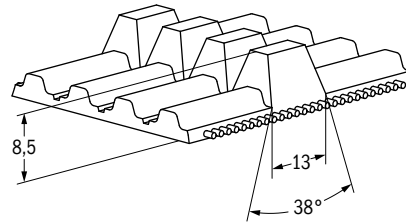

### MIN PULLEY DIAMETER:

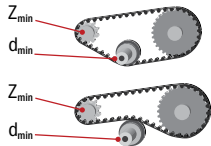

	STEEL	ARAMID
<b>z min</b>	25	25
<b>d min</b>	80	80
<b>z min</b>	28	28
<b>d min</b>	80	80

POLYURETHANE	HARDNESS [°SHORE A]	TEMPERATURE RANGE [°C]	FEATURE
R1	92	-5 to +70	Standard
R2	85	-10 to +60	
FDA	85	-10 to +60	With Aramid Cord Only

## TECHNICAL DATA

STANDARD WIDTH (MM)	UNIT	25	32	50	75	100	150
<b>BREAKING FORCE / AVERAGE VALUE</b>							
Steel	[N]	7.140	9.240	14.700	22.260	29.820	44.940
Aramid	[N]	9.163	11.880	18.865	28.567	38.269	57.673
<b>ALLOWABLE BELT FORCE / OPEN ENDED</b>							
Steel	[N]	1.909	2.470	3.929	5.950	7.971	12.012
Aramid	[N]	1.064	1.379	2.190	3.316	4.442	6.694
<b>ALLOWABLE BELT FORCE / ENDLESS WELDED</b>							
Steel	[N]	954	1.235	1.965	2.975	3.985	6.006
Aramid	[N]	798	1.034	1.642	2.487	3.331	5.020
<b>ALLOWABLE EFFECTIVE FORCE / MINIMUM 12 TEETH IN MESH</b>							
	[N]	683	1.081	2.105	3.528	4.950	7.795
<b>BELT WEIGHT</b>							
Steel	[kg/m]	0,18	0,21	0,29	0,40	0,50	0,72
Aramid	[kg/m]	0,16	0,18	0,25	0,34	0,43	0,61
<b>SPECIFIC BELT STIFFNESS</b>							
Steel	[N]	477.125	617.456	928.316	1.487.507	1.992.699	3.003.081
Aramid	[N]	265.875	344.699	547.390	828.904	1.110.419	1.673.449



**AT5V / PITCH: 5MM**

**PRODUCT SPECIFICATIONS**

<b>PITCH</b>	5 mm
<b>INTEGRATED V-GUIDE</b>	K6
<b>WIDTH TOLERANCE</b>	
< 50MM WIDTH	+ -0,50 mm
> 50MM WIDTH	+ -0,75 mm
<b>MINIMUM WELDED BELT LENGTH</b>	960 mm
<b>STANDARD ROLL LENGTH (TOLERANCE ±1%)</b>	100 m
<b>STANDARD COLOR</b>	White
<b>FDA/EU APPROVAL</b>	Option
<b>POLYAMIDE FABRIC</b>	Optional NT, NB & NTB

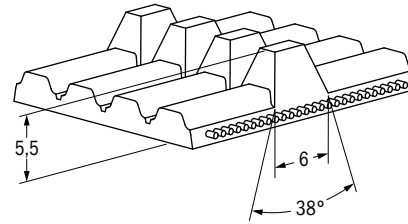

**MIN PULLEY DIAMETER:**

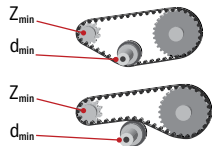

	STEEL	ARAMID
<b>z min</b>	25	25
<b>d min</b>	60	60
<b>z min</b>	28	28
<b>d min</b>	80	80

POLYURETHANE	HARDNESS [° SHORE A]	TEMPERATURE RANGE [° C]	FEATURE
R1	92	-5 to +70	Standard
R2	85	-10 to +60	
FDA	85	-10 to +60	With Aramid Cord Only

**TECHNICAL DATA**

STANDARD WIDTH (MM)	UNIT	16	25	32	50
<b>BREAKING FORCE / AVERAGE VALUE</b>					
Steel	[N]	4.275	7.125	9.120	14.535
Aramid	[N]	5.224	8.350	10.782	17.034
<b>ALLOWABLE BELT FORCE / OPEN ENDED</b>					
Steel	[N]	1.056	1.761	2.253	3.591
Aramid	[N]	757	1.210	1.562	2.468
<b>ALLOWABLE BELT FORCE / ENDLESS WELDED</b>					
Steel	[N]	528	880	1.127	1.796
Aramid	[N]	568	908	1.172	1.851
<b>ALLOWABLE EFFECTIVE FORCE / MINIMUM 12 TEETH IN MESH</b>					
	[N]	480	912	1.248	2.112
<b>BELT WEIGHT</b>					
Steel	[kg/m]	0,08	0,10	0,12	0,18
Aramid	[kg/m]	0,07	0,09	0,11	0,16
<b>SPECIFIC BELT STIFFNESS</b>					
Steel	[N]	264.075	440.125	563.360	897.855
Aramid	[N]	189.244	302.500	390.588	617.100

**ATL5V / PITCH: 5MM**

**PRODUCT SPECIFICATIONS**

<b>PITCH</b>	5 mm
<b>INTEGRATED V-GUIDE</b>	K6
<b>WIDTH TOLERANCE</b>	
< 50MM WIDTH	+ -0,50 mm
> 50MM WIDTH	+ -0,75 mm
<b>MINIMUM WELDED BELT LENGTH</b>	960 mm
<b>STANDARD ROLL LENGTH (TOLERANCE ±1%)</b>	100 m
<b>STANDARD COLOR</b>	White
<b>FDA/EU APPROVAL</b>	No
<b>POLYAMIDE FABRIC</b>	Optional NT, NB & NTB

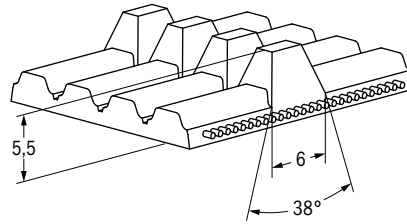

**MIN PULLEY DIAMETER:**

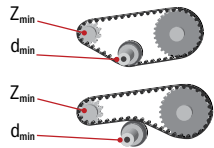

	STEEL
<b>z min</b>	25
<b>d min</b>	60
<b>z min</b>	28
<b>d min</b>	80

POLYURETHANE	HARDNESS [°SHORE A]	TEMPERATURE RANGE [°C]	FEATURE
R1	92	-5 to +70	Standard
R2	85	-10 to +60	

**TECHNICAL DATA**

STANDARD WIDTH (MM)	UNIT	16	25	32	50
<b>BREAKING FORCE / AVERAGE VALUE</b>					
Steel	[N]	6.200	10.540	13.640	21.700
<b>ALLOWABLE BELT FORCE / OPEN ENDED</b>					
Steel	[N]	1.376	2.340	3.028	4.818
<b>ALLOWABLE BELT FORCE / ENDLESS WELDED</b>					
Steel	[N]	688	1.170	1.514	2.409
<b>ALLOWABLE EFFECTIVE FORCE / MINIMUM 12 TEETH IN MESH</b>					
	[N]	480	912	1.248	2.112
<b>BELT WEIGHT</b>					
Steel	[kg/m]	0,08	0,11	0,14	0,20
<b>SPECIFIC BELT STIFFNESS</b>					
Steel	[N]	344.118	585.000	757.059	1.204.412

# AT10VS / PITCH: 10MM

**PRODUCT SPECIFICATIONS**

<b>PITCH</b>	10 mm
<b>INTEGRATED V-GUIDE</b>	K6
<b>WIDTH TOLERANCE</b>	
< 50MM WIDTH	+ -0,75 mm
> 50MM WIDTH	+ -1,00 mm
<b>MINIMUM WELDED BELT LENGTH</b>	1.000 mm
<b>STANDARD ROLL LENGTH (TOLERANCE ±1%)</b>	100 m
<b>STANDARD COLOR</b>	White
<b>FDA/EU APPROVAL</b>	Option
<b>POLYAMIDE FABRIC</b>	Optional NT, NB & NTB

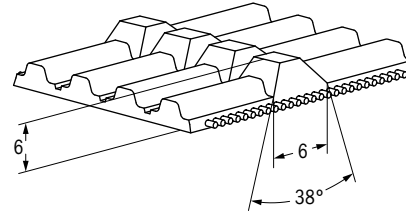

**MIN PULLEY DIAMETER:**

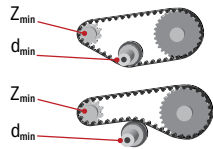

	STEEL	ARAMID
<b>z min</b>	20	20
<b>d min</b>	80	80
<b>z min</b>	25	25
<b>d min</b>	120	120

POLYURETHANE	HARDNESS [°SHORE A]	TEMPERATURE RANGE [°C]	FEATURE
R1	92	-5 to +70	Standard
R2	85	-10 to +60	
FDA	85	-10 to +60	With Aramid Cord Only

**TECHNICAL DATA**

STANDARD WIDTH (MM)	UNIT	25	32	50	75	100	150
<b>BREAKING FORCE / AVERAGE VALUE</b>							
Steel	[N]	14.250	18.050	29.450	44.650	59.850	90.250
Aramid	[N]	16.185	21.019	33.449	50.713	67.977	102.505
<b>ALLOWABLE BELT FORCE / OPEN ENDED</b>							
Steel	[N]	3.741	4.739	7.731	11.722	15.712	23.693
Aramid	[N]	1.750	2.273	3.617	5.483	7.350	11.083
<b>ALLOWABLE BELT FORCE / ENDLESS WELDED</b>							
Steel	[N]	1.871	2.369	3.866	5.861	7.856	11.847
Aramid	[N]	1.313	1.705	2.713	4.113	5.513	8.313
<b>ALLOWABLE EFFECTIVE FORCE / MINIMUM 12 TEETH IN MESH</b>							
	[N]	1.961	2.683	4.541	7.121	9.701	14.861
<b>BELT WEIGHT</b>							
Steel	[kg/m]	0,21	0,25	0,35	0,50	0,64	0,93
Aramid	[kg/m]	0,17	0,20	0,28	0,38	0,41	0,62
<b>SPECIFIC BELT STIFFNESS</b>							
Steel	[N]	935.250	1.184.650	1.932.850	2.930.450	3.928.050	5.923.250
Aramid	[N]	437.500	568.167	904.167	1.370.833	1.837.500	2.770.833

# AT10V / PITCH: 10MM

## PRODUCT SPECIFICATIONS

<b>PITCH</b>	10 mm
<b>INTEGRATED V-GUIDE</b>	K13
<b>WIDTH TOLERANCE</b>	
< 50MM WIDTH	+ -0,75 mm
> 50MM WIDTH	+ -1,00 mm
<b>MINIMUM WELDED BELT LENGTH</b>	1.000 mm
<b>STANDARD ROLL LENGTH (TOLERANCE ±1%)</b>	50m Optional 100m
<b>STANDARD COLOR</b>	White
<b>FDA/EU APPROVAL</b>	Option
<b>POLYAMIDE FABRIC</b>	Optional NT, NB & NTB

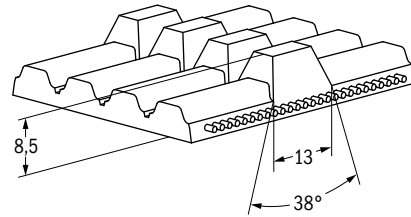

### MIN PULLEY DIAMETER:

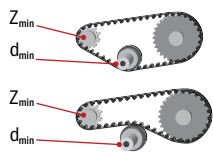

	STEEL	ARAMID	STEEL HF	STAINLESS
<b>z min</b>	25	25	20	32
<b>d min</b>	80	80	60	130
<b>z min</b>	28	28	25	35
<b>d min</b>	120	120	100	150

POLYURETHANE	HARDNESS [° SHORE A]	TEMPERATURE RANGE [°C]	FEATURE
R1	92	-5 to +70	Standard
R2	85	-10 to +60	
FDA	85	-10 to +60	With Aramid Cord Only

## TECHNICAL DATA

STANDARD WIDTH (MM)	UNIT	25	32	50	75	100	150
<b>BREAKING FORCE / AVERAGE VALUE</b>							
Steel	[N]	14.250	18.050	29.450	44.650	59.850	90.250
Aramid	[N]	16.185	21.019	33.449	50.713	67.977	102.505
Steel HF	[N]	12.975	16.435	26.815	40.655	N/A	N/A
Stainless	[N]	10.688	13.538	22.088	33.488	N/A	N/A
<b>ALLOWABLE BELT FORCE / OPEN ENDED</b>							
Steel	[N]	3.741	4.739	7.731	11.722	15.712	23.693
Aramid	[N]	1.750	2.273	3.617	5.483	7.350	11.083
Steel HF	[N]	3.456	4.378	7.142	10.829	N/A	N/A
Stainless	[N]	2.806	3.554	5.799	8.791	N/A	N/A
<b>ALLOWABLE BELT FORCE / ENDLESS WELDED</b>							
Steel	[N]	1.871	2.369	3.866	5.861	7.856	11.847
Aramid	[N]	1.313	1.705	2.713	4.113	5.513	8.313
Steel HF	[N]	1.728	2.189	3.571	5.414	N/A	N/A
Stainless	[N]	1.403	1.777	2.899	4.396	N/A	N/A
<b>ALLOWABLE EFFECTIVE FORCE / MINIMUM 12 TEETH IN MESH</b>							
	[N]	1.238	1.961	3.818	6.398	8.978	14.138
<b>BELT WEIGHT</b>							
Steel	[kg/m]	0,21	0,25	0,35	0,50	0,64	0,93
Aramid	[kg/m]	0,17	0,20	0,28	0,38	0,49	0,68
Steel HF	[kg/m]	0,20	0,24	0,34	0,48	N/A	N/A
Stainless	[kg/m]	0,21	0,25	0,35	0,49	N/A	N/A
<b>SPECIFIC BELT STIFFNESS</b>							
Steel	[N]	935.250	1.184.650	1.932.850	2.930.450	3.928.050	5.923.500
Aramid	[N]	437.500	568.167	904.167	1.370.833	1.837.500	2.770.833
Steel HF	[N]	864.000	1.094.400	1.785.600	2.707.200	N/A	N/A
Stainless	[N]	701.438	888.488	1.449.639	2.197.839	N/A	N/A

**AT20V / PITCH: 20MM****PRODUCT SPECIFICATIONS**

<b>PITCH</b>	20 mm
<b>INTEGRATED V-GUIDE</b>	K13
<b>WIDTH TOLERANCE</b>	
< 50MM WIDTH	+ -1,0 mm
> 50MM WIDTH	+ -1,50 mm
<b>MINIMUM WELDED BELT LENGTH</b>	1.000 mm
<b>STANDARD ROLL LENGTH (TOLERANCE ±1%)</b>	50 m
<b>STANDARD COLOR</b>	White
<b>FDA/EU APPROVAL</b>	No
<b>POLYAMIDE FABRIC</b>	Optional NT, NB & NTB

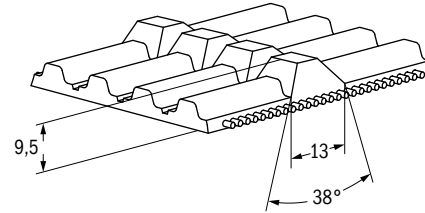
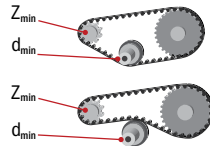
**MIN PULLEY DIAMETER:**

	STEEL	ARAMID
<b>z min</b>	20	20
<b>d min</b>	127.3	127.3
<b>z min</b>	25	25
<b>d min</b>	180	180

POLYURETHANE	HARDNESS [° SHORE A]	TEMPERATURE RANGE [° C]	FEATURE
R1	92	-5 to +70	Standard

**TECHNICAL DATA**

STANDARD WIDTH (MM)	UNIT	32	50	75	100	150
<b>BREAKING FORCE / AVERAGE VALUE</b>						
Steel	[N]	31.140	50.170	76.120	102.070	153.970
Aramid	[N]	28.337	45.153	68.508	91.863	138.573
<b>ALLOWABLE BELT FORCE / OPEN ENDED</b>						
Steel	[N]	7.534	12.139	18.417	24.696	37.253
Aramid	[N]	2.585	4.120	6.251	8.382	12.643
<b>ALLOWABLE BELT FORCE / ENDLESS WELDED</b>						
Steel	[N]	3.767	6.069	9.209	12.139	18.626
Aramid	[N]	1.939	3.090	4.688	6.286	9.483
<b>ALLOWABLE EFFECTIVE FORCE / MINIMUM 12 TEETH IN MESH</b>						
	[N]	4.142	8.066	13.516	18.966	29.866
<b>BELT WEIGHT</b>						
Steel	[kg/m]	0,31	0,48	0,73	0,97	1,45
Aramid	[kg/m]	0,23	0,37	0,55	0,73	1,10
<b>SPECIFIC BELT STIFFNESS</b>						
Steel	[N]	1.883.571	3.034.643	4.604.286	6.173.929	9.313.214
Aramid	[N]	646.373	1.029.935	1.562.660	2.095.385	3.160.836

**HV / PITCH: 0.50"**

**PRODUCT SPECIFICATIONS**

<b>PITCH</b>	0,500" / 12,7mm
<b>INTEGRATED V-GUIDE</b>	A-Section
<b>WIDTH TOLERANCE</b>	
< 2" / 50 MM WIDTH	+,-0,020" / +,-0,5 mm
> 2" / 50 MM WIDTH	+,-0,030" / +,-0,75 mm
<b>MINIMUM WELDED BELT LENGTH</b>	36" / 914,4 mm
<b>STANDARD ROLL LENGTH (TOLERANCE ±1%)</b>	100 m
<b>STANDARD COLOR</b>	White
<b>FDA/EU APPROVAL</b>	Option
<b>POLYAMIDE FABRIC</b>	Optional NT, NB & NTB

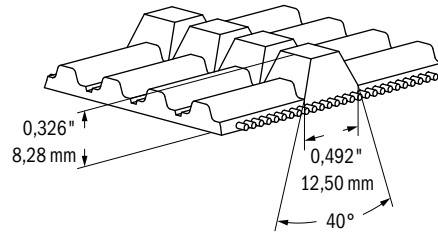

**MIN PULLEY DIAMETER:**

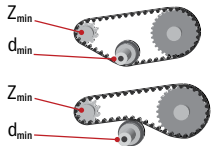

	STEEL	ARAMID
<b>z min</b>	20	20
<b>d min</b>	80	80
<b>z min</b>	22	22
<b>d min</b>	120	120

POLYURETHANE	HARDNESS [°SHORE A]	TEMPERATURE RANGE [°C]	FEATURE
R1	92	-5 to +70	Standard
R2	85	-10 to +60	
FDA	85	-10 to +60	With Aramid Cord Only

**TECHNICAL DATA**

STANDARD WIDTH (MM)	UNIT	1,5"/38,1MM	2"/50,8MM	3"/76,2MM	4"/101,6MM	6"/152,4MM
<b>BREAKING FORCE / AVERAGE VALUE</b>						
Steel	[N]	10.920	14.700	22.260	29.820	44.940
Aramid	[N]	14.014	18.865	28.567	38.269	57.673
<b>ALLOWABLE BELT FORCE / OPEN ENDED</b>						
Steel	[N]	2.919	3.929	5.950	7.971	12.012
Aramid	[N]	1.657	2.127	3.221	4.315	6.503
<b>ALLOWABLE BELT FORCE / ENDLESS WELDED</b>						
Steel	[N]	1.459	1.965	2.975	3.985	6.006
Aramid	[N]	1.185	1.595	2.416	3.236	4.877
<b>ALLOWABLE EFFECTIVE FORCE / MINIMUM 12 TEETH IN MESH</b>						
	[N]	1.663	2.488	4.138	5.788	9.088
<b>BELT WEIGHT</b>						
Steel	[kg/m]	0,22	0,27	0,37	0,47	0,67
Aramid	[kg/m]	0,19	0,23	0,31	0,39	0,56
<b>SPECIFIC BELT STIFFNESS</b>						
Steel	[N]	729.721	982.316	1.487.507	1.992.699	3.003.081
Aramid	[N]	395.014	531.750	805.221	1.078.693	1.625.636

**HVO / PITCH: 0.50"****PRODUCT SPECIFICATIONS**

<b>PITCH</b>	0,500" / 12,7mm
<b>INTEGRATED V-GUIDE</b>	0-Section
<b>WIDTH TOLERANCE</b>	
< 2" / 50 MM WIDTH	+0,020" / +0,5 mm
> 2" / 50 MM WIDTH	+0,030" / +0,75 mm
<b>MINIMUM WELDED BELT LENGTH</b>	36" / 914,4 mm
<b>STANDARD ROLL LENGTH (TOLERANCE ±1%)</b>	200 ft / 61 m
<b>STANDARD COLOR</b>	Clear
<b>FDA/EU APPROVAL</b>	Option
<b>POLYAMIDE FABRIC</b>	Optional NT, NB & NTB

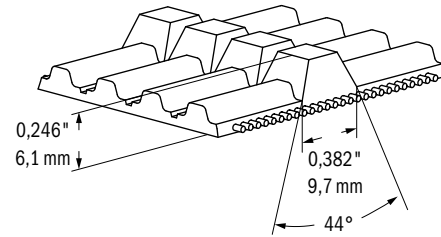
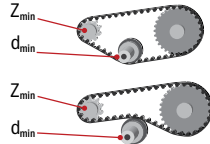
**MIN PULLEY DIAMETER:**

	STEEL	ARAMID
<b>z min</b>	20	20
<b>d min</b>	80	80
<b>z min</b>	22	22
<b>d min</b>	120	120

POLYURETHANE	HARDNESS [° SHORE A]	TEMPERATURE RANGE [° C]	FEATURE
R1	92	-5 to +70	Standard
R2	85	-10 to +60	
FDA	85	-10 to +60	With Aramid Cord Only

**TECHNICAL DATA**

STANDARD WIDTH ("/MM)	UNIT	1,5"/38,1MM	2"/50,8MM	3"/76,2MM	4"/101,6MM	6"/152,4MM
<b>BREAKING FORCE / AVERAGE VALUE</b>						
Steel	[N]	10.920	14.700	22.260	29.820	44.940
Aramid	[N]	14.014	18.865	28.567	38.269	57.673
<b>ALLOWABLE BELT FORCE / OPEN ENDED</b>						
Steel	[N]	2.919	3.929	5.950	7.971	12.012
Aramid	[N]	1.657	2.127	3.221	4.315	6.503
<b>ALLOWABLE BELT FORCE / ENDLESS WELDED</b>						
Steel	[N]	1.459	1.965	2.975	3.985	6.006
Aramid	[N]	1.185	1.595	2.416	3.236	4.877
<b>ALLOWABLE EFFECTIVE FORCE / MINIMUM 12 TEETH IN MESH</b>						
	[N]	1.845	2.670	4.320	5.970	9.270
<b>BELT WEIGHT</b>						
Steel	[kg/m]	0,19	0,25	0,35	0,45	0,65
Aramid	[kg/m]	0,16	0,21	0,29	0,37	0,56
<b>SPECIFIC BELT STIFFNESS</b>						
Steel	[N]	729.721	982.316	1.487.507	1.992.699	3.003.081
Aramid	[N]	395.014	531.750	805.221	1.078.693	1.625.636

**WHV / PITCH: 0,50" / 12,7MM**

**PRODUCT SPECIFICATIONS**

<b>PITCH</b>	0,500" / 12,7mm
<b>INTEGRATED V-GUIDE</b>	A-Section
<b>MINIMUM WELDED BELT LENGTH</b>	43,5" / 1104,9 mm
<b>STANDARD ROLL LENGTH (TOLERANCE ±1%)</b>	200 feet / 61 m
<b>STANDARD COLOR</b>	Clear
<b>FDA/EU APPROVAL</b>	Option
<b>POLYAMIDE FABRIC</b>	Optional NT, NB & NTB

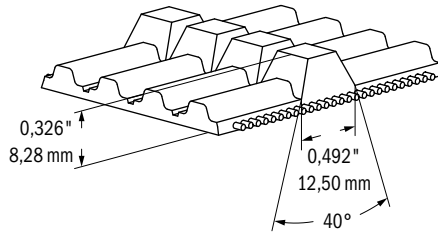

**MIN PULLEY DIAMETER:**

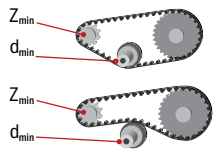

	ARAMID
<b>z min</b>	14
<b>d min</b>	2,23" / 56,64 mm
<b>z min</b>	14
<b>d min</b>	13,12" / 79,24 mm

POLYURETHANE	HARDNESS [° SHORE A]	TEMPERATURE RANGE [° C]	FEATURE
R1	92	-5 to +70	Standard
R2	85	-10 to +60	
FDA	85	-10 to +60	

**TECHNICAL DATA**

STANDARD WIDTH (MM)	UNIT	6" / 152,4 MM	8" / 203,2 MM	10" / 254 MM	12" / 304,8 MM	14" / 355,6 MM	18" / 457,2 MM
<b>BREAKING FORCE / AVERAGE VALUE</b>							
Aramid	[N]	25.333	34.496	43.120	51.744	60.368	77.077
<b>ALLOWABLE BELT FORCE / OPEN ENDED</b>							
Aramid	[N]	6.750	9.191	11.489	13.787	16.085	20.537
<b>ALLOWABLE BELT FORCE / ENDLESS WELDED</b>							
Aramid	[N]	3.375	4.596	5.745	6.894	8.042	10.269
<b>ALLOWABLE EFFECTIVE FORCE / MINIMUM 12 TEETH IN MESH</b>							
	[N]	9.075	12.375	15.675	18.975	22.275	28.875
<b>BELT WEIGHT</b>							
Aramid	[kg/m]	0,5	0,7	0,8	1,0	1,1	1,4
<b>SPECIFIC BELT STIFFNESS</b>							
Aramid	[N]	843.744	1.148.928	1.436.160	1.723.392	2.010.624	2.567.136





# GATES TPU PINLOK

## MECHANICAL JOINING SYSTEM

Gates PinLok™ is mechanical belt joining system that allows belt installation without machine disassembly.

- Ideal for applications where it is difficult to install & replace belts
- Easy on-site assembly
- Available in various pitches up to 100mm width
- Works with steel or Aramid cord
- Available for belt with special backings or profiles



### PRODUCT SPECIFICATIONS

<b>MAXIMUM BELT SPEED</b>	2 m/s
<b>SERVICE TEMPERATURE</b>	0 -50 °C
<b>MINIMUM LENGTH</b>	
< 50MM WIDTH	600mm
75 AND 100MM WIDTH	1000mm

### PINLOK (SECTION)

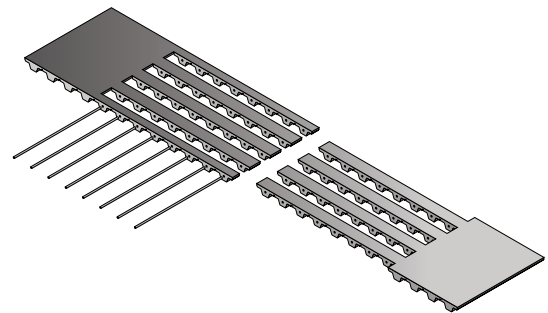

	MINIMUM NUMBER OF PULLEY TEETH	MINIMUM BACK BEND DIAMETER
<b>T10</b>	16	80
<b>T10V, T10VS</b>	25	80
<b>T20</b>	16	120
<b>AT5</b>	20	80
<b>AT10, HTD8M</b>	16	120
<b>AT10V, AT10VS</b>	25	120
<b>H</b>	16	80
<b>HV</b>	25	80

### TECHNICAL DATA

PITCH / STANDARD WIDTH (MM)	16	25	32	50	75	100
AT5	280	525				
T10, T10V*, T10VS*		395	450	825	1250	1675
AT10		660	770	1365	1760	2070
HTD8M		660	770	1365		
AT10V, AT10VS*, T20			770	1365	1760	2070
PITCH / STANDARD WIDTH (MM)		1"	1,5"	2"	3"	4"
H, HV**		395	450	825	1250	1675

Allowable Tension is valid for all available cord constructions.  
 \* T10V, T10VS and AT10VS are available in 32mm and 50mm only  
 \*\* HV available in 1" and 2" only

# SYNCHRO-POWER FLAT

## FLAT BELTS

Gates TPU flat belts made from high strength polyurethane are produced in standard rolls or open ended belts and are commonly used in lifting and pulling applications. Flat belts are typically attached at one or both ends with clamping plates or with our new FIX-FLAT clamping system

Our flat belts are suited for a wide range of mechanical requirements. We offer various combinations of polyurethane types and cords to support the diverse needs of the market.

We also have a range of belts specially designed for applications in the food processing industry that are FDA and EU approved.

**OUR LATEST DEVELOPMENT FIX-FLAT, THE FLAT BELT CLAMP, ENABLES THE SECURE CLAMPING OF ANY FLAT BELTS AT BOTH ENDS EASILY, QUICKLY AND SAFELY.**



### FEATURES

- Smooth, vibration free operation
- High strength combined with low elongation
- Sealed belt edges result in no cord fraying
- Easy belt guide with flanged pulleys or guiding rails
- No re-tensioning required

### TYPICAL APPLICATIONS:

- Heavy load lifting or lowering
- Exercise machines
- Applications with small pulley diameters

### PROCESSING OPTIONS:

- Backings Further information on page 96
- Profiles Further information on page 102
- Special processing Further information on page 108

### CLAMP CONNECTION

- Clamp FIX-FLAT Further information on page 63

## F 20

## PRODUCT SPECIFICATIONS

STANDARD THICKNESS	2 mm
MINIMUM WELDED BELT LENGTH	880 mm
WIDTH TOLERANCE	
< 50MM WIDTH	+/- 0,5 mm
> 50MM WIDTH	+/- 0,75 mm
STANDARD ROLL LENGTH (TOLERANCE ±1%)	100 m
STANDARD COLOR	Black
FDA/EU APPROVAL	No
POLYAMIDE FABRIC	Optional NT, NB & NTB

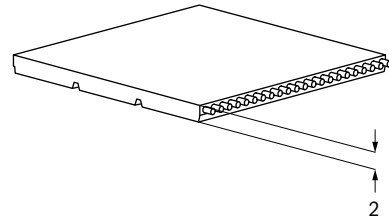

## MIN PULLEY DIAMETER:

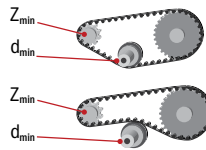

	STEEL	ARAMID	STEEL HF	STEEL RSL	ARAMID RKV	STEEL RHF	STEEL NIRO
Pulley on Flight side	35	35	30	48	48	38	64
Idler on the back	60	60	50	72	72	57	96

POLYURETHANE	HARDNESS [°SHORE A]	TEMPERATURE RANGE [°C]	FEATURE
R1	92	-5 to +70	Standard
R2	85	-10 to +60	

## TECHNICAL DATA

STANDARD WIDTH (MM)	UNIT	10	16	25	50	75	100	150
<b>BREAKING FORCE / AVERAGE VALUE</b>								
Steel	[N]	2.604	4.418	7.140	14.700	22.260	29.820	44.940
Aramid	[N]	2.911	4.980	8.085	16.709	25.333	33.957	51.205
Steel HF	[N]	3.844	6.522	10.540	21.700	32.860	44.020	66.340
Steel RSL	[N]	5.130	8.778	14.250	29.450	44.650	59.850	90.250
Aramid RKV	[N]	5.827	9.970	16.158	33.449	50.713	67.977	102.505
Steel RHF	[N]	4.671	7.993	12.975	26.815	40.655	54.495	82.175
Steel NIRO	[N]	3.848	6.584	10.688	22.068	33.488	44.888	67.688
<b>ALLOWABLE BELT FORCE / OPEN ENDED</b>								
Steel	[N]	842	1.403	2.386	4.912	7.438	9.963	15.015
Aramid	[N]	443	798	1.329	2.747	4.165	5.583	8.419
Steel HF	[N]	1.032	1.721	2.925	6.022	9.119	12.216	18.410
Steel RSL	[N]	1.559	2.806	4.676	9.664	14.652	19.640	29.616
Aramid RKV	[N]	729	1.313	2.188	4.521	6.854	9.188	13.854
Steel RHF	[N]	1.440	2.592	4.320	8.928	13.536	18.144	27.360
Steel NIRO	[N]	1.169	2.104	3.507	7.248	10.989	14.730	22.212
<b>ALLOWABLE BELT FORCE / ENDLESS WELDED</b>								
Steel	[N]	421	702	1.193	2.456	3.719	4.982	7.508
Aramid	[N]	222	399	665	1.347	2.083	2.792	4.210
Steel HF	[N]	516	860	1.463	3.011	4.560	6.108	9.205
Steel RSL	[N]	779	1.403	2.338	4.832	7.326	9.820	14.808
Aramid RKV	[N]	365	656	1.094	2.260	3.427	4.594	6.927
Steel RHF	[N]	720	1.296	2.160	4.464	6.768	9.072	13.680
Steel NIRO	[N]	585	1.052	1.754	3.624	5.495	7.365	11.106
<b>BELT WEIGHT</b>								
Steel	[kg/m]	0.03	0.05	0.07	0.15	0.22	0.30	0.45
Aramid	[kg/m]	0.02	0.04	0.06	0.11	0.17	0.23	0.34
Steel HF	[kg/m]	0.03	0.05	0.08	0.17	0.25	0.33	0.50
Steel RSL	[kg/m]	0.04	0.06	0.09	0.19	0.28	0.38	0.57
Aramid RKV	[kg/m]	0.02	0.04	0.05	0.11	0.16	0.22	0.33
Steel RHF	[kg/m]	0.04	0.06	0.09	0.18	0.26	0.35	0.53
Steel NIRO	[kg/m]	0.04	0.06	0.09	0.19	0.28	0.37	0.56
<b>SPECIFIC BELT STIFFNESS</b>								
Steel	[N]	168.397	280.662	477.125	982.316	1.487.507	1.992.699	3.003.081
Aramid	[N]	88.625	159.525	265.875	549.475	833.075	1.116.675	1.683.875
Steel HF	[N]	206.471	344.118	585.000	1.204.412	1.823.824	2.443.235	3.682.059
Steel RSL	[N]	311.750	561.150	935.250	1.932.850	2.930.450	3.928.050	5.923.250
Aramid RKV	[N]	145.833	262.500	437.500	904.167	1.370.833	1.837.500	2.770.833
Steel RHF	[N]	288.000	518.400	864.000	1.785.600	2.707.200	3.628.800	5.472.000
Steel NIRO	[N]	233.813	420.863	701.438	1.449.639	2.197.839	2.946.040	4.442.441

# F30

## PRODUCT SPECIFICATIONS

<b>STANDARD THICKNESS</b>	3 mm
<b>MINIMUM WELDED BELT LENGTH</b>	880 mm
<b>WIDTH TOLERANCE</b>	
< 50MM WIDTH	+/- 1,0 mm
> 50MM WIDTH	+/- 1,5 mm
<b>STANDARD ROLL LENGTH (TOLERANCE ±1%)</b>	100 m
<b>STANDARD COLOR</b>	Black
<b>FDA/EU APPROVAL</b>	No
<b>POLYAMIDE FABRIC</b>	Optional NT, NB & NTB

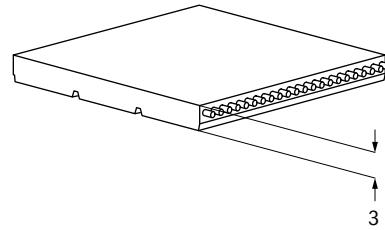

### MIN PULLEY DIAMETER:

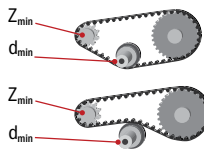

	STEEL	ARAMID	ARAMID RKV	STEEL HF	STEEL RSL
<b>Pulley on Flight side</b>	80	60	80	64	160
<b>Idler on the back</b>	120	120	120	96	240

POLYURETHANE	HARDNESS [°SHORE A]	TEMPERATURE RANGE [°C]	FEATURE
R1	92	-5 to +70	Standard
R2	85	-10 to +60	

## TECHNICAL DATA

STANDARD WIDTH (MM)	UNIT	10	16	25	50	75	100	150
<b>BREAKING FORCE / AVERAGE VALUE</b>								
Steel	[N]	8.650	14.878	24.220	50.170	76.120	102.070	153.970
Aramid	[N]	2.910	4.980	8.085	16.709	25.333	33.957	51.205
Aramid RKV	[N]	7.785	13.390	21.798	45.153	65.508	91.863	138.573
Steel HF	[N]	9.625	16.555	26.950	55.825	84.700	113.575	171.325
Steel RSL	[N]	11.520	20.352	33.600	70.400	107.200	144.000	217.600
<b>ALLOWABLE BELT FORCE / OPEN ENDED</b>								
Steel	[N]	2.616	4.186	7.325	15.173	23.021	30.870	46.566
Aramid	[N]	443	798	1.329	2.747	4.165	5.583	8.419
Aramid RKV	[N]	781	1.250	2.188	4.531	6.875	9.219	13.906
Steel HF	[N]	2.267	3.628	6.349	13.151	19.953	26.755	40.360
Steel RSL	[N]	4.446	7.114	8.892	19.563	29.345	40.016	60.469
<b>ALLOWABLE BELT FORCE / ENDLESS WELDED</b>								
Steel	[N]	1.308	2.093	3.663	7.587	11.511	15.435	23.283
Aramid	[N]	222	399	665	1.374	2.083	2.792	4.210
Aramid RKV	[N]	391	625	1.094	2.266	3.438	4.609	6.953
Steel HF	[N]	1.134	1.814	3.174	6.575	9.977	13.378	20.180
Steel RSL	[N]	N/A	N/A	N/A	N/A	N/A	N/A	N/A
<b>BELT WEIGHT</b>								
Steel	[kg/m]	0,06	0,09	0,15	0,29	0,44	0,59	0,88
Aramid	[kg/m]	0,03	0,05	0,08	0,15	0,23	0,31	0,46
Aramid RKV	[kg/m]	0,03	0,05	0,08	0,16	0,24	0,32	0,48
Steel HF	[kg/m]	0,06	0,10	0,16	0,32	0,48	0,64	0,96
Steel RSL	[kg/m]	0,07	0,11	0,18	0,35	0,53	0,70	1,06
<b>SPECIFIC BELT STIFFNESS</b>								
Steel	[N]	523.214	837.143	1.465.000	3.034.643	4.604.286	6.173.929	9.313.214
Aramid	[N]	88.625	159.525	265.875	549.475	833.075	1.116.675	1.683.875
Aramid RKV	[N]	156.250	250.000	437.500	906.250	1.375.000	1.843.750	2.781.250
Steel HF	[N]	453.482	725.571	1.269.750	2.630.196	3.990.643	5.351.089	8.071.982
Steel RSL	[N]	889.249	1.422.798	1.778.498	3.912.696	5.869.043	8.003.241	12.093.786

## F48

## PRODUCT SPECIFICATIONS

STANDARD THICKNESS	4,8 mm
WIDTH TOLERANCE	+/- 2,0 mm
STANDARD ROLL LENGTH (TOLERANCE ±1%)	50 m
STANDARD COLOR	Black
FDA/EU APPROVAL	No
POLYAMIDE FABRIC	Optional NT, NB & NTB

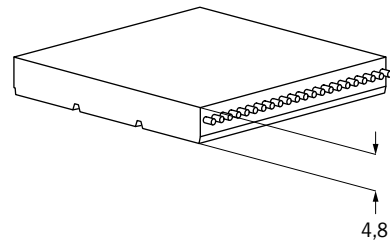

## MIN PULLEY DIAMETER:

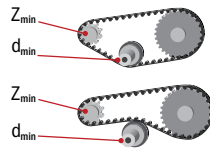

	STEEL
Pulley on Flight side	150
Idler on the back	225

POLYURETHANE	HARDNESS [° SHORE A]	TEMPERATURE RANGE [° C]	FEATURE
R1	92	-5 to +70	Standard
R2	85	-10 to +60	

## TECHNICAL DATA

STANDARD WIDTH (MM)	UNIT	25	50	75	100	150
<b>BREAKING FORCE / AVERAGE VALUE</b>						
Steel	[N]	45.000	97.500	150.000	202.500	307.500
<b>ALLOWABLE BELT FORCE / OPEN ENDED</b>						
Steel	[N]	13.378	28.986	44.594	60.201	91.417
<b>ALLOWABLE BELT FORCE / ENDLESS WELDED</b>						
Steel	[N]	N/A	N/A	N/A	N/A	N/A
<b>BELT WEIGHT</b>						
Steel	[kg/m]	0,27	0,54	0,81	1,08	1,62
<b>SPECIFIC BELT STIFFNESS</b>						
Steel	[N]	2.675.622	5.797.181	8.918.740	12.040.299	18.283.417



# LRB-45 LIVE ROLLER DRIVE BELT

## HIGH SPEED AND DURABLE INTRALOGISTICS BELT SOLUTION

The LRB-45 belt is an open ended flat belt with a high grip top side to the live rollers and a low friction and anti-static fabric bottom side to improve safety and reliability. Aramid reinforcement ensures a safe and longer lifespan operation for our customers' warehouse and distribution conveyors.



### LRB-45 (SECTION)

#### PRODUCT SPECIFICATIONS

	METRIC	IMPERIAL
<b>STANDARD THICKNESS</b>	4.7 +/- 0.2 mm	0.184 +/- 0.008 in
<b>STANDARD ROLL LENGTH*</b>	up to 152 m	500 ft
<b>STANDARD COLOR</b>	Black	Black
<b>CORD</b>	Aramid	Aramid
<b>MINIMUM PULLEY DIAMETER</b>	100 mm	3.94 in
<b>FDA/EU APPROVAL</b>	No	No
<b>POLYURETHANE</b>	92° Shore A	92° Shore A
<b>TOP SURFACE</b>	Knurled Polyurethane	Knurled Polyurethane
<b>BOTTOM SURFACE</b>	Antistatic Fabric	Antistatic Fabric
<b>OPERATING TEMPERATURE</b>	-25°C to +80°C	-13°F to 175°F
<b>SPLICE</b>	Interleaved finger heat welded	Interleaved finger heat welded
<b>RECOMMEND FINGER LENGTH</b>	155 mm (min.)	6.1 in (min.)

#### TECHNICAL DATA

<b>STANDARD WIDTH</b>	45 +0/-1 mm	1.77 +0/-0.04 in
<b>ULTIMATE TENSILE STRENGTH</b>	33300 N	7490 lbf
<b>ALLOWABLE BELT TENSION</b>	4450 N	1000 lbf
<b>SPECIFIC BELT WEIGHT</b>	0,21 kg/m	1.52lb/ft
<b>SPECIFIC BELT STIFFNESS</b>	731.370 N	164,420 lbf

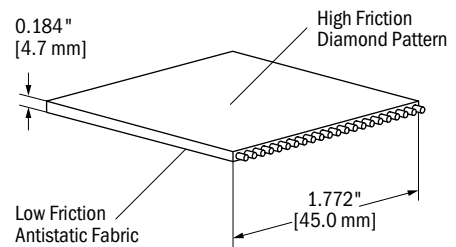

#### FEATURES + BENEFITS

- High friction, knurled diamond pattern on top ensures high grip and less slip on the rollers
- Low friction antistatic fabric on the bottom prevents static load buildup
- Aramid cord design for lower stretch and longer life compared to competitor belts
- Designed to be spliced with OEM equipment
- Available in roll lengths up to 660 ft (200 meters)



# CLAMP CONNECTION FIX-FLAT

## FIX FLAT

OUR LATEST DEVELOPMENT FIX-FLAT, THE FLAT BELT CLAMP, ENABLES THE SECURE CLAMPING OF ANY FLAT BELTS AT BOTH ENDS EASILY, QUICKLY AND SAFELY.

The patented Flat Belt Clamp holds all types of Flat Belts easily and safely. The FIX-FLAT process is suitable for all Flat belt constructions.

MORE INFORMATION IS AVAILABLE ON REQUEST.

### FEATURES

- Suitable for all types of flat belts.
- Easy
- Safe
- Fast



FIX FLAT CLAMP DIMENSIONS											
DIMENSION [MM]	L	H	D	P	e	f	W				
							Belt width 25	Belt width 50	Belt width 75	Belt width 100	Belt width 150
HTD8	66	15	9	8	5	8	50	75	100	125	175
HTD14	116	22	11	14	9	10	56	81	106	131	181

CLAMPING F30 STEEL RSL OR F48 STEEL: 2 CLAMPING PLATES ARE REQUIRED

TYPE	PITCH
F20 Steel	HTD8
F20 ARAMID	HTD8
F20 Steel HF	HTD8
F20 Steel RSL	HTD8
F20 ARAMID RKV	HTD8
F20 RHF	HTD8
F20 NIRO	HTD8
F30 Steel	HTD14
F30 ARAMID	HTD8
F30 ARAMID RKV	HTD14
F30 STEEL HF	HTD14
F30 Steel RSL	HTD14
F48 STEEL	HTD14

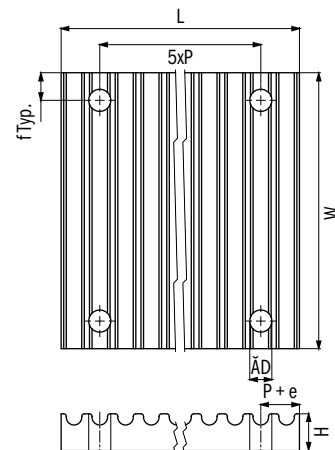



# SYNCHRO-POWER WIDE

## WIDE BELTS

Gates TPU Wide Belts are ideal for conveying applications that require greater than 150mm width, precise product positioning, and smooth-running operation. The high strength aramid cords ensure even tension characteristics. The high quality polyurethane is cut resistant and non-marking, making this belt ideal for abrasive environments.

**GATES TPU WIDE BELTS OFFER AN ALTERNATIVE TO PLASTIC MODULAR AND CONVEYOR BELTING WITH OUR EASY TO CLEAN, ABRASION RESISTANT, SMOOTH DRIVE WIDE BELTS.**

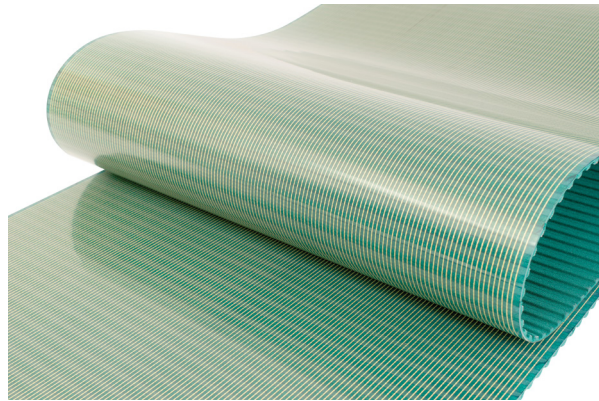

### ATTRIBUTES

- Easy to clean
- Cut resistant
- Widths up to 450 mm available
- Suitable for synchronous conveying applications
- No cord exposure at the edges of the belt
- Low-noise, smooth operation
- FDA and EU food approval for various pitches

### APPLICATIONS

- Synchronous conveying applications
- Bulk conveying
- Food and confectionary conveying
- Clean room or wash down environments
- Hygienic applications

### PROCESSING OPTIONS

- Backings Further information on page 96
- Profiles Further information on page 102
- Special processing Further information on page 108



**GMT3 / PITCH: 3MM****PRODUCT SPECIFICATIONS**

<b>PITCH</b>	3 mm
<b>STANDARD THICKNESS</b>	2,8 mm
<b>MINIMUM WELDED BELT LENGTH</b>	1.200 mm
<b>STANDARD ROLL LENGTH (TOLERANCE ±1%)</b>	60 m
<b>STANDARD COLOR</b>	Blue Optional White
<b>FDA/EU APPROVAL</b>	Option
<b>POLYAMIDE FABRIC</b>	NA

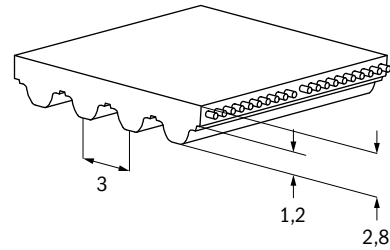
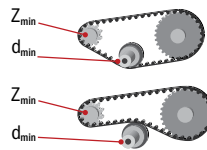
**MIN PULLEY DIAMETER:**

	ARAMID
<b>z min</b>	19
<b>d min</b>	18
<b>z min</b>	19
<b>d min</b>	30

POLYURETHANE	HARDNESS [° SHORE A]	TEMPERATURE RANGE [° C]
R2	85	-10 to +60
FDA	85	-10 to +60

**TECHNICAL DATA**

STANDARD WIDTH (MM)	UNIT	50	100	150	200	250	300	350	450
<b>BREAKING FORCE / AVERAGE VALUE</b>									
Aramid	[N]	3.363	6.851	10.338	13.826	17.313	20.801	24.288	30.018
<b>ALLOWABLE BELT FORCE / OPEN ENDED</b>									
Aramid	[N]	498	1.014	1.530	2.046	2.561	3.077	3.593	4.441
<b>ALLOWABLE BELT FORCE / ENDLESS WELDED</b>									
Aramid	[N]	373	760	1.147	1.534	1.921	2.308	2.695	3.331
<b>ALLOWABLE EFFECTIVE FORCE / MINIMUM 12 TEETH IN MESH</b>									
	[N]	1.200	2.400	3.600	4.800	6.000	7.200	8.400	10.800
<b>BELT WEIGHT</b>									
Aramid	[kg/m]	0,1	0,2	0,3	0,4	0,5	0,6	0,7	0,9
<b>SPECIFIC BELT STIFFNESS</b>									
Aramid	[N]	124.389	253.385	382.381	511.377	640.373	769.369	898.365	1.110.287

**WT5 / PITCH: 5MM**

**PRODUCT SPECIFICATIONS**

<b>PITCH</b>	5 mm
<b>STANDARD THICKNESS</b>	2,5 mm
<b>MINIMUM WELDED BELT LENGTH</b>	810 mm
<b>STANDARD ROLL LENGTH</b>	100 m
<b>STANDARD COLOR</b>	White, Optional Clear
<b>FDA/EU APPROVAL</b>	Option
<b>POLYAMIDE FABRIC</b>	Optional NT, NB & NTB

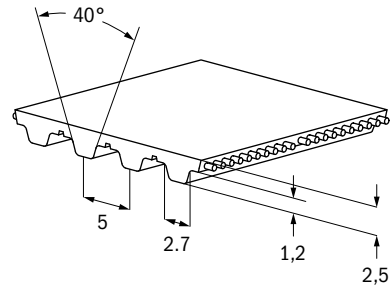

**MIN PULLEY DIAMETER:**

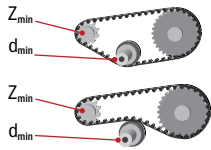

	ARAMID
<b>z min</b>	10
<b>d min</b>	15.91
<b>z min</b>	10
<b>d min</b>	30

POLYURETHANE	HARDNESS [° SHORE A]	TEMPERATURE RANGE [° C]	FEATURE
R1	92	-5 to +70	Standard
R2	85	-10 to +60	
FDA	85	-10 to +60	

**TECHNICAL DATA**

STANDARD WIDTH (MM)	UNIT	150	200
<b>BREAKING FORCE / AVERAGE VALUE</b>			
Aramid	[N]	25.730	34.410
<b>ALLOWABLE BELT FORCE / OPEN ENDED</b>			
Aramid	[N]	2.814	3.764
<b>ALLOWABLE BELT FORCE / ENDLESS WELDED</b>			
Aramid	[N]	2.111	2.823
<b>ALLOWABLE EFFECTIVE FORCE / MINIMUM 12 TEETH IN MESH</b>			
	[N]	3.750	5.000
<b>BELT WEIGHT</b>			
Aramid	[kg/m]	0,3	0,4
<b>SPECIFIC BELT STIFFNESS</b>			
Aramid	[N]	703.579	940.931

**WT10 / PITCH: 10MM****PRODUCT SPECIFICATIONS**

<b>PITCH</b>	10 mm
<b>STANDARD THICKNESS</b>	4,5 mm
<b>MINIMUM WELDED BELT LENGTH</b>	1.100 mm
<b>STANDARD ROLL LENGTH (TOLERANCE ±1%)</b>	60 m
<b>STANDARD COLOR</b>	Clear
<b>FDA/EU APPROVAL</b>	Option
<b>POLYAMIDE FABRIC</b>	Optional NT, NB & NTB

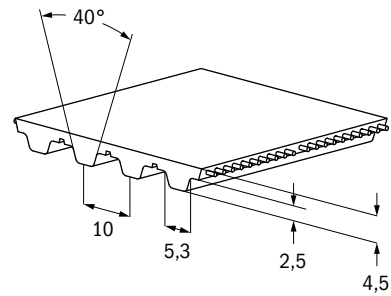
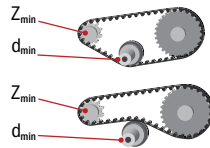
**MIN PULLEY DIAMETER:**

	ARAMID
<b>z min</b>	14
<b>d min</b>	44.56
<b>z min</b>	14
<b>d min</b>	80

POLYURETHANE	HARDNESS [° SHORE A]	TEMPERATURE RANGE [° C]	FEATURE
R1	92	-5 to +70	Standard
R2	85	-10 to +60	
FDA	85	-10 to +60	

**TECHNICAL DATA**

STANDARD WIDTH (MM)	UNIT	150	200	250	300	450
<b>BREAKING FORCE / AVERAGE VALUE</b>						
Aramid	[N]	25.333	33.957	42.581	51.205	77.077
<b>ALLOWABLE BELT FORCE / OPEN ENDED</b>						
Aramid	[N]	6.750	9.048	11.346	13.644	20.537
<b>ALLOWABLE BELT FORCE / ENDLESS WELDED</b>						
Aramid	[N]	3.375	4.524	5.673	6.822	10.269
<b>ALLOWABLE EFFECTIVE FORCE / MINIMUM 12 TEETH IN MESH</b>						
	[N]	8.535	11.380	14.225	17.070	25.605
<b>BELT WEIGHT</b>						
Aramid	[kg/m]	0,6	0,8	1,0	1,2	1,8
<b>SPECIFIC BELT STIFFNESS</b>						
Aramid	[N]	843.744	1.130.976	1.418.208	1.705.440	2.567.136

**WHTD8M / PITCH: 8MM**

**PRODUCT SPECIFICATIONS**

<b>PITCH</b>	8 mm
<b>STANDARD THICKNESS</b>	5,6 mm
<b>MINIMUM WELDED BELT LENGTH</b>	952 mm
<b>STANDARD ROLL LENGTH (TOLERANCE ±1%)</b>	60 m
<b>STANDARD COLOR</b>	White
<b>FDA/EU APPROVAL</b>	Option
<b>POLYAMIDE FABRIC</b>	Optional NT, NB & NTB

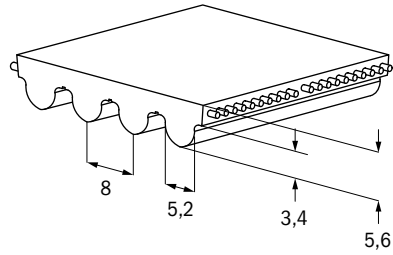

**MIN PULLEY DIAMETER:**

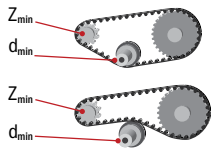

	ARAMID
<b>z min</b>	20
<b>d min</b>	51
<b>z min</b>	20
<b>d min</b>	120

POLYURETHANE	HARDNESS [° SHORE A]	TEMPERATURE RANGE [° C]	FEATURE
R1	92	-5 to +70	Standard
R2	85	-10 to +60	
FDA	85	-10 to +60	

**TECHNICAL DATA**

STANDARD WIDTH (MM)	UNIT	150	200	250	300	450
<b>BREAKING FORCE / AVERAGE VALUE</b>						
Aramid	[N]	102.505	137.033	171.561	206.089	309.673
<b>ALLOWABLE BELT FORCE / OPEN ENDED</b>						
Aramid	[N]	16.625	22.225	27.825	33.425	50.225
<b>ALLOWABLE BELT FORCE / ENDLESS WELDED</b>						
Aramid	[N]	8.313	11.113	13.913	16.713	25.113
<b>ALLOWABLE EFFECTIVE FORCE / MINIMUM 12 TEETH IN MESH</b>						
	[N]	13.950	18.600	23.250	27.900	41.850
<b>BELT WEIGHT</b>						
Aramid	[kg/m]	0,7	0,9	1,2	1,4	2,1
<b>SPECIFIC BELT STIFFNESS</b>						
Aramid	[N]	2.770.833	3.704.167	4.637.500	5.570.833	8.370.833

**WH / PITCH: 0,500" / 12,7MM**

**PRODUCT SPECIFICATIONS**

<b>PITCH</b>	0,500" / 12,7 mm
<b>STANDARD THICKNESS</b>	0,160" / 4,06 mm
<b>MINIMUM WELDED BELT LENGTH</b>	43,5" / 1104,9 mm
<b>STANDARD ROLL LENGTH (TOLERANCE ±1%)</b>	200 feet / 61 m
<b>STANDARD COLOR</b>	Clear
<b>FDA/EU APPROVAL</b>	Option
<b>POLYAMIDE FABRIC</b>	Optional NT, NB & NTB

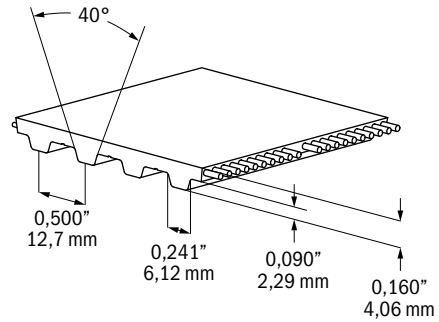

**MIN PULLEY DIAMETER:**

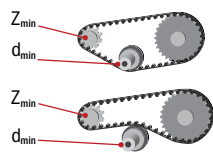

	ARAMID
<b>z min</b>	14
<b>d min</b>	2,23" / 56,64 mm
<b>z min</b>	14
<b>d min</b>	3,12" / 79,24 mm

POLYURETHANE	HARDNESS [°SHORE A]	TEMPERATURE RANGE [°C]	FEATURE
R1	92	-5 to +70	Standard
R2	85	-10 to +60	
FDA	85	-10 to +60	

**TECHNICAL DATA**

STANDARD WIDTH ("/MM)	UNIT	6"/152,4MM	8"/203,2MM	10"/254MM	12"/304,8MM	14"/355,6MM	18"/457,2MM
<b>BREAKING FORCE / AVERAGE VALUE</b>							
Aramid	[N]	25.333	34.496	43.120	51.744	60.368	77.077
<b>ALLOWABLE BELT FORCE / OPEN ENDED</b>							
Aramid	[N]	6.750	9.191	11.489	13.787	16.085	20.537
<b>ALLOWABLE BELT FORCE / ENDLESS WELDED</b>							
Aramid	[N]	3.375	4.596	5.745	6.894	8.042	10.269
<b>ALLOWABLE EFFECTIVE FORCE / MINIMUM 12 TEETH IN MESH</b>							
	[N]	9.900	13.200	16.500	19.800	23.100	29.700
<b>BELT WEIGHT</b>							
Aramid	[kg/m]	0,5	0,7	0,8	1,0	1,1	1,4
<b>SPECIFIC BELT STIFFNESS</b>							
Aramid	[N]	843.744	1.148.928	1.436.160	1.723.392	2.010.624	2.567.136

**CC8 / PITCH: 8MM**

**PRODUCT SPECIFICATIONS**

<b>PITCH</b>	8 mm
<b>STANDARD THICKNESS</b>	6 mm
<b>MINIMUM WELDED BELT LENGTH</b>	1004 mm
<b>STANDARD ROLL LENGTH (TOLERANCE ±1%)</b>	61 m
<b>STANDARD COLOR</b>	PosiBlue
<b>FDA/EU APPROVAL</b>	FDA Only
<b>POLYAMIDE FABRIC</b>	NA

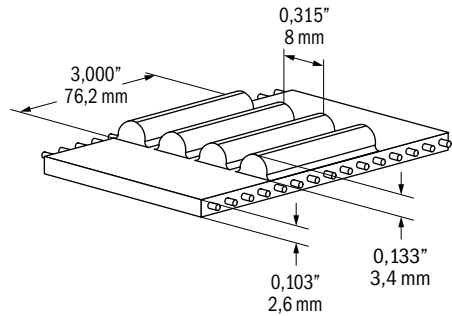

CC8 RUNS IN HTD8 PULLEYS  
MIN PULLEY DIAMETER:

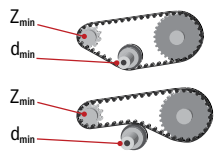

	ARAMID
<b>z min</b>	20
<b>d min</b>	51
<b>z min</b>	20
<b>d min</b>	120

POLYURETHANE	HARDNESS [° SHORE A]	TEMPERATURE RANGE [° C]	FEATURE
FG	90	-5 to +70	Standard

**TECHNICAL DATA**

STANDARD WIDTH (\"/>						
<b>BREAKING FORCE / AVERAGE VALUE</b>						
Aramid	[N]	16.170	18.326	20.482	22.638	24.794
<b>ALLOWABLE BELT FORCE / OPEN ENDED</b>						
Aramid	[N]	3.231	3.662	4.093	4.524	4.955
<b>ALLOWABLE BELT FORCE / ENDLESS WELDED</b>						
Aramid	[N]	1.616	1.831	2.047	2.262	2.477
<b>ALLOWABLE EFFECTIVE FORCE / MINIMUM 12 TEETH IN MESH</b>						
	[N]	6.975	6.975	6.975	6.975	6.975
<b>BELT WEIGHT</b>						
Aramid	[kg/m]	0,67	0,84	1,01	1,17	1,51
<b>SPECIFIC BELT STIFFNESS</b>						
Aramid	[N]	538.560	610.368	682.176	753.984	825.792



# MECHANICAL FABRICATION PROCESSES

Gates TPU offers a wide range of TPU Wide Belt modifications within our full range of fabrication options. Gates TPU wide belt solutions include grinding edges to tight tolerances, punching or machining holes and slots, and CNC machining of 3-dimensional contours.



## APPLICATIONS

- Vacuum conveying belts - machined tooth side & perforations
- Precision machined belts for precise product movement
- Distinct product orientation and location within automated processing

# SYNCHRO-POWER SLEEVE

## SLEEVE BELTS

Gates TPU Synchro-Power Sleeve Belts are designed to meet the higher strength and stiffness requirements that certain power transmission and high-performance positioning applications demand.

Our Synchro-Power Sleeves belts are cast on fixed molds and have continuously wound steel cords that provide more strength and stiffness than a welded belt can provide. They are manufactured in various exact sizes, constructions, and pitches to fulfill customer requirements.

**CAST ENDLESS BELTS OFFER PREMIUM CAPACITY FOR POWER TRANSMISSIONS AND ROTARY POSITIONING APPLICATIONS WHILE MEETING A BROAD RANGE OF LOADS, SPEEDS, AND APPLICATION REQUIREMENTS.**



### ATTRIBUTES

- High quality thermo-set polyurethane construction
- Helically wound steel cords for high strength, truly endless power transmission capabilities.
- Excellent abrasion resistance
- Smooth, low noise, non-marking operation
- High tooth strength reduces deforming under load
- Excellent resistance to chemicals

### APPLICATIONS

- Paper processing industry
- Wood processing industry
- Glass processing industry
- Textile industry
- Packaging machines
- Exercise equipment

### FURTHER INFORMATION

- Backings Further information on page 96
- Special processing Further information on page 108



**T2,5 / PITCH: 2,5MM****PRODUCT SPECIFICATIONS**

<b>PITCH</b>	2,5 mm
<b>STANDARD THICKNESS</b>	1,3 mm
<b>STANDARD POLYURETHANE R3</b>	84° ShoreA
<b>STANDARD COLOR</b>	Blue
<b>FDA/EU APPROVAL</b>	No

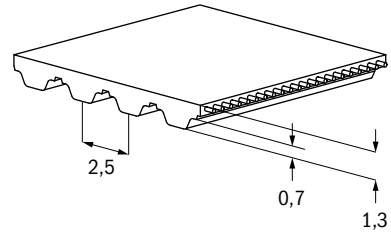
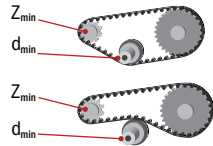
**MIN PULLEY DIAMETER:**

	STEEL	ARAMID
<b>z min</b>	10	10
<b>d min</b>	7,96	7,96
<b>z min</b>	10	10
<b>d min</b>	15	15

**TECHNICAL DATA**

STANDARD WIDTH (MM)	UNIT	4	6	8	10	12	16	20	25	32	50
<b>BREAKING FORCE / AVERAGE VALUE</b>											
Steel	[N]	340	540	740	1.000	1.200	1.680	2.080	2.680	3.400	5.400
Aramid	[N]	500	800	1.095	1.500	1.800	2.500	3.100	4.000	5.100	8.100
<b>ALLOWABLE BELT FORCE</b>											
Steel	[N]	85	135	180	250	300	420	520	670	850	1.350
Aramid	[N]	100	160	220	300	360	500	620	800	1.020	1.620
<b>ALLOWABLE EFFECTIVE FORCE / MINIMUM 12 TEETH IN MESH</b>											
	[N]	32	48	64	80	96	128	160	200	256	400
<b>BELT WEIGHT</b>											
Steel	[kg/m]	0,01	0,01	0,01	0,01	0,01	0,02	0,03	0,03	0,04	0,07
Aramid	[kg/m]	0,01	0,01	0,01	0,01	0,01	0,02	0,02	0,02	0,03	0,05

**T2,5 / PITCH: 2,5MM**

LENGTH [MM]	WIDTH [MM]	NUMBER OF TEETH
120	200	48
145	200	58
160	200	64
177.5	200	71
180	200	72
200	200	80
210	200	84
230	200	92
245	200	98
265	200	106
277.5	200	111
285	200	114
290	200	116
305	200	122

LENGTH [MM]	WIDTH [MM]	NUMBER OF TEETH
317.5	200	127
330	380	132
342.5	380	137
380	380	152
420	380	168
480	380	192
500	380	200
540	380	216
600	380	240
620	380	248
650	380	260
780	380	312
915	380	366
950	380	380

**T5 / PITCH: 5MM**

**PRODUCT SPECIFICATIONS**

<b>PITCH</b>	5 mm
<b>STANDARD THICKNESS</b>	2,2 mm
<b>STANDARD THICKNESS DL</b>	3,4 mm
<b>STANDARD POLYURETHANE R3</b>	84° ShoreA
<b>STANDARD COLOR</b>	Blue
<b>FDA/EU APPROVAL</b>	No

**MIN PULLEY DIAMETER:**

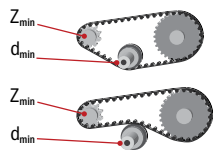

	STEEL
<b>z min</b>	10
<b>d min</b>	15,92
<b>z min</b>	10
<b>d min</b>	30

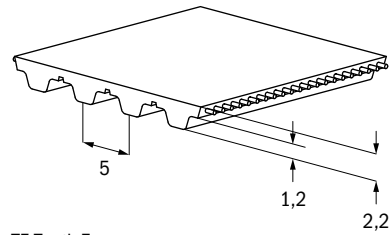

T5 Tooth Form

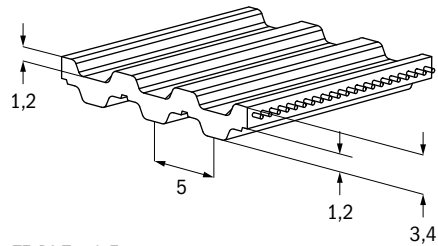

T5-DL Tooth Form

**TECHNICAL DATA**

STANDARD WIDTH (MM)	UNIT	4	6	8	10	12	16	20	25	32	50	75
<b>BREAKING FORCE / AVERAGE VALUE</b>												
Steel	[N]	570	880	1.180	1.500	1.880	2.640	3.360	4.240	5.500	8.600	13.200
Aramid	[N]	820	1.250	1.685	2.150	2.700	3.750	4.850	6.100	7.900	12.400	18.900
<b>ALLOWABLE BELT FORCE</b>												
Steel	[N]	135	220	295	375	470	660	840	1.060	1.375	2.150	3.300
Aramid	[N]	155	250	330	430	540	750	970	1.220	1.580	2.480	3.780
<b>ALLOWABLE EFFECTIVE FORCE / MINIMUM 12 TEETH IN MESH</b>												
	[N]	100	150	200	250	300	400	500	625	800	1.250	1.875
<b>BELT WEIGHT</b>												
Steel	[kg/m]	0,01	0,01	0,02	0,02	0,02	0,03	0,04	0,05	0,07	0,11	0,16
Aramid	[kg/m]	0,01	0,01	0,01	0,02	0,02	0,02	0,03	0,04	0,05	0,08	0,12
Steel DL	[kg/m]	0,01	0,01	0,02	0,02	0,03	0,04	0,05	0,06	0,08	0,13	0,19
Aramid DL	[kg/m]	0,01	0,01	0,02	0,02	0,02	0,03	0,04	0,05	0,06	0,10	0,15

**T5**

LENGTH [MM]	WIDTH [MM]	NUMBER OF TEETH
165	200	33
185	200	37
200	200	40
215	200	43
220	200	44
225	200	45
245	200	49
250	200	50
255	200	51
260	200	52
270	200	54
275	200	55
280	200	56
295	200	59
300	200	60
305	200	61
320	200	64
325	380	65
330	380	66
340	380	68
350	380	70
355	380	71
365	380	73
375	380	75
390	380	78
400	380	80
410	380	82
420	380	84
425	380	85
430	380	86
440	380	88
445	380	89
450	380	90
455	380	91
460	380	92
475	380	95
480	380	96
500	380	100

LENGTH [MM]	WIDTH [MM]	NUMBER OF TEETH
510	380	102
525	380	105
545	380	109
550	380	110
560	380	112
575	380	115
590	380	118
600	380	120
610	380	122
620	380	124
625	380	125
630	380	126
640	380	128
650	380	130
660	380	132
675	380	135
690	380	138
700	380	140
720	380	144
725	380	145
750	380	150
780	380	156
800	380	160
815	380	163
840	380	168
850	380	170
900	380	180
940	380	188
990	380	198
1000	380	200
1075	380	215
1100	380	220
1215	380	243
1315	380	263
1350	380	270
1380	380	276
1440	380	288

**DL T5**

LENGTH [MM]	WIDTH [MM]	NUMBER OF TEETH
300	200	60
400	380	80
410	380	82
450	380	90
460	380	92
480	380	96
500	380	100
515	380	103
550	380	110
590	380	118
600	380	120
620	380	124
650	380	130
700	380	140
750	380	150
815	380	163
900	380	180
940	380	188
1100	380	220

# T10 / PITCH: 10MM

## PRODUCT SPECIFICATIONS

<b>PITCH</b>	10 mm
<b>STANDARD THICKNESS</b>	4,5 mm
<b>STANDARD THICKNESS DL</b>	7,0 mm
<b>STANDARD POLYURETHANE R3</b>	84° ShoreA
<b>STANDARD COLOR</b>	Blue
<b>FDA/EU APPROVAL</b>	No

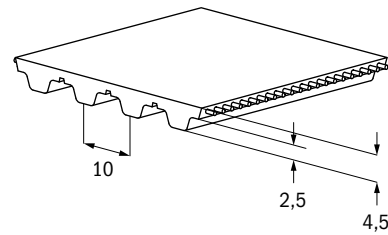

T10 Tooth Form

### MIN PULLEY DIAMETER:

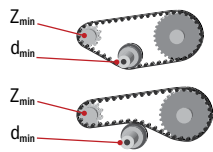

	STEEL	ARAMID
<b>z min</b>	12	12
<b>d min</b>	38,2	38,2
<b>z min</b>	12	12
<b>d min</b>	60	60

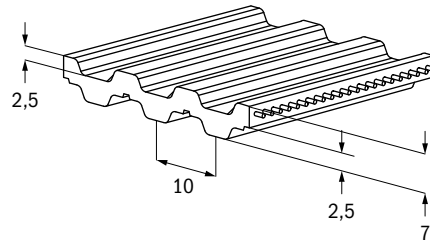

T10-DL Tooth Form

## TECHNICAL DATA

STANDARD WIDTH (MM)	UNIT	10	12	16	20	25	32	50	75
<b>BREAKING FORCE / AVERAGE VALUE</b>									
Steel	[N]	3.360	4.200	5.900	7.600	9.700	12.600	20.200	30.700
Aramid	[N]	4.000	5.000	7.000	9.000	11.500	15.000	24.000	36.500
<b>ALLOWABLE BELT FORCE</b>									
Steel	[N]	840	1.050	1.475	1.900	2.425	3.150	5.050	7.675
Aramid	[N]	800	1.000	1.400	1.800	2.300	3.000	4.800	7.300
<b>ALLOWABLE EFFECTIVE FORCE / MINIMUM 12 TEETH IN MESH</b>									
	[N]	569	683	911	1.138	1.423	1.821	2.846	4.269
<b>BELT WEIGHT</b>									
Steel	[kg/m]	0,04	0,05	0,07	0,09	0,11	0,14	0,23	0,34
Aramid	[kg/m]	0,03	0,04	0,05	0,06	0,08	0,10	0,16	0,24
Steel DL	[kg/m]	0,06	0,07	0,09	0,11	0,14	0,18	0,29	0,44
Aramid DL	[kg/m]	0,04	0,05	0,07	0,09	0,11	0,14	0,23	0,34

**T10**

LENGTH [MM]	WIDTH [MM]	NUMBER OF TEETH
260	200	26
320	200	32
370	380	37
400	380	40
410	380	41
440	380	44
450	380	45
500	380	50
530	380	53
550	380	55
560	380	56
600	380	60
610	380	61
630	380	63
650	380	65
660	380	66
690	380	69
700	380	70
720	380	72
750	380	75
780	380	78
800	380	80
810	380	81
840	380	84
850	380	85
880	380	88
890	380	89
900	380	90
910	380	91
920	380	92
950	380	95
960	380	96
970	380	97

LENGTH [MM]	WIDTH [MM]	NUMBER OF TEETH
980	380	98
1000	380	100
1010	380	101
1050	380	105
1080	380	108
1100	380	110
1110	380	111
1140	380	114
1150	380	115
1200	380	120
1210	380	121
1240	380	124
1250	380	125
1300	380	130
1320	380	132
1350	380	135
1390	380	139
1400	380	140
1420	380	142
1440	380	144
1450	380	145
1460	380	146
1500	380	150
1560	380	156
1600	200	160
1610	200	161
1700	200	170
1750	200	175
1780	200	178
1800	200	180
1880	200	188
1960	200	196
2250	200	225

**DL T10**

LENGTH [MM]	WIDTH [MM]	NUMBER OF TEETH
600	380	60
630	380	63
660	380	66
700	380	70
750	380	75
800	380	80
840	380	84
900	380	90
980	380	98
1000	380	100
1100	380	110
1200	380	120
1210	380	121
1300	380	130
1320	380	132
1420	380	142
1600	200	160
1610	200	161
1700	200	170
1880	200	188

# AT5 / PITCH: 5MM

## PRODUCT SPECIFICATIONS

<b>PITCH</b>	5 mm
<b>STANDARD THICKNESS</b>	2,7 mm
<b>STANDARD POLYURETHANE R3</b>	84°ShoreA
<b>STANDARD COLOR</b>	Blue
<b>FDA/EU APPROVAL</b>	No

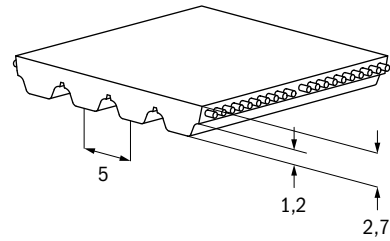

### MIN PULLEY DIAMETER:

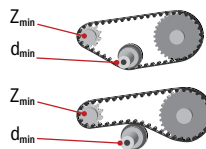

	STEEL
<b>z min</b>	15
<b>d min</b>	23,87
<b>z min</b>	15
<b>d min</b>	50

## TECHNICAL DATA

STANDARD WIDTH (MM)	UNIT	4	6	8	10	12	16	20	25	32	50	75
<b>BREAKING FORCE / AVERAGE VALUE</b>												
Steel	[N]	723	1.420	2.065	2.860	3.700	5.100	6.560	8.300	10.800	17.100	26.400
Aramid	[N]	823	1.250	1.690	2.150	2.700	3.775	4.850	6.100	7.900	12.400	18.900
<b>ALLOWABLE BELT FORCE</b>												
Steel	[N]	181	355	516	715	925	1.275	1.640	2.075	2.700	4.275	6.550
Aramid	[N]	157	250	334	430	540	755	970	1.220	1.580	2.480	3.780
<b>ALLOWABLE EFFECTIVE FORCE / MINIMUM 12 TEETH IN MESH</b>												
	[N]	160	240	320	400	480	640	800	1.000	1.280	2.000	3.000
<b>BELT WEIGHT</b>												
Steel	[kg/m]	0,01	0,02	0,02	0,03	0,04	0,05	0,06	0,08	0,10	0,17	0,25
Aramid	[kg/m]	0,01	0,01	0,02	0,02	0,02	0,03	0,04	0,06	0,07	0,12	0,18

# AT5 / PITCH: 5MM

LENGTH [MM]	WIDTH [MM]	NUMBER OF TEETH
225	200	45
280	200	56
300	200	60
340	380	68
375	380	75
390	380	78
420	380	84
450	380	90
455	380	91
500	380	100
545	380	109
600	380	120

LENGTH [MM]	WIDTH [MM]	NUMBER OF TEETH
610	380	122
660	380	132
710	380	142
720	380	144
750	380	150
780	380	156
825	380	165
860	380	172
975	380	195
1050	380	210
1500	380	300

# AT10 / PITCH: 10MM

## PRODUCT SPECIFICATIONS

PITCH	10 mm
STANDARD THICKNESS	5,0 mm
STANDARD POLYURETHANE R3	84°ShoreA
STANDARD COLOR	Blue
FDA/EU APPROVAL	No

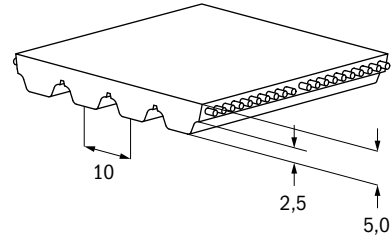

### MIN PULLEY DIAMETER:

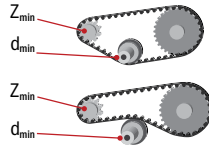

	STEEL	ARAMID
<b>z min</b>	15	15
<b>d min</b>	47,75	47,75
<b>z min</b>	15	15
<b>d min</b>	120	120

## TECHNICAL DATA

STANDARD WIDTH (MM)	UNIT	10	12	16	20	25	32	50	75
<b>BREAKING FORCE / AVERAGE VALUE</b>									
Steel	[N]	4.760	5.700	8.560	10.500	14.300	18.100	29.500	45.600
Aramid	[N]	5.500	6.600	9.900	12.100	16.500	20.900	34.100	52.800
<b>ALLOWABLE BELT FORCE</b>									
Steel	[N]	1.190	1.425	2.140	2.625	3.575	4.525	7.375	11.450
Aramid	[N]	1.100	1.320	1.980	2.420	3.300	4.180	6.820	10.560
<b>ALLOWABLE EFFECTIVE FORCE / MINIMUM 12 TEETH IN MESH</b>									
	[N]	890	1.068	1.424	1.780	2.225	2.848	4.450	6.675
<b>BELT WEIGHT</b>									
Steel	[kg/m]	0,07	0,08	0,10	0,13	0,16	0,21	0,33	0,49
Aramid	[kg/m]	0,04	0,05	0,07	0,09	0,11	0,14	0,22	0,33

# AT10 / PITCH: 10MM

LENGTH [MM]	WIDTH [MM]	NUMBER OF TEETH
500	380	50
560	380	56
610	380	61
660	380	66
700	380	70
730	380	73
780	380	78
800	380	80
840	380	84
890	380	89
920	380	92
960	380	96

LENGTH [MM]	WIDTH [MM]	NUMBER OF TEETH
980	380	98
1.010	380	101
1.050	380	105
1.080	380	108
1.100	380	110
1.150	380	115
1.200	380	120
1.210	380	121
1.250	380	125
1.280	380	128
1.320	380	132
1.350	380	135

LENGTH [MM]	WIDTH [MM]	NUMBER OF TEETH
1.360	380	136
1.400	380	140
1.420	380	142
1.480	380	148
1.500	380	150
1.600	200	160
1.700	200	170
1.800	200	180
1.860	200	186
1.940	200	194



# SYNCHRO-POWER FLEX

## FLEX BELTS

Gates TPU Synchro-Power Flex Belts are designed for high power transmission drives and heavy load conveying applications.

Our flex belts are available in both standard and low-temperature urethanes to suit a range of application environments. Enhanced with our full range of backing and profile options, we are able to create customized conveying and positioning solutions.

**FLEX BELTS ARE TRULY ENDLESS EXTRUDED BELTS PRODUCED WITH HELICALLY WOUND STEEL CORDS AND ABRASION-RESISTANT POLYURETHANE, A CONSTRUCTION THAT PROVIDES LONG LASTING BELT SYSTEM SOLUTIONS FOR EVEN THE MOST DEMANDING INDUSTRIES AND APPLICATIONS.**

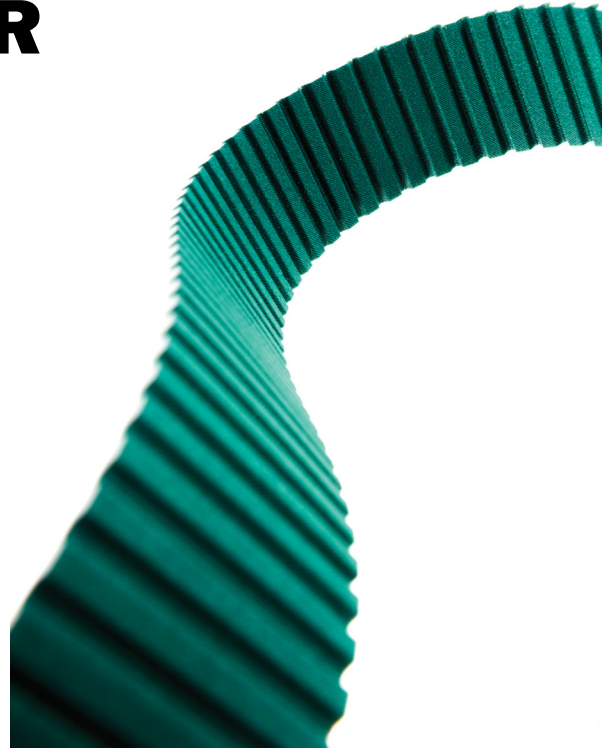

### ATTRIBUTES

- Extruded, thermoplastic polyurethane construction
- High performance and power transmission based on truly endless cords
- Synchronous tracking

### APPLICATIONS

- Glass & Ceramics
- Packaging
- Intralogistics
- Wood, Paper & Furniture
- Textile industry
- Machine tools
- Power transmission
- High load conveying applications

### PROCESSING OPTIONS

- Backings Further information on page 96
- Profiles Further information on page 102
- Special processing Further information on page 108

Further constructions are available on request.



**T5 / PITCH: 5MM****PRODUCT SPECIFICATIONS**

<b>PITCH</b>	5 mm
<b>SLEEVE WIDTH</b>	100 mm
<b>WIDTH TOLERANCE</b>	
< 50MM WIDTH	+0,5 mm
> 50MM WIDTH	+0,75 mm
<b>LENGTH RANGE</b>	1.520 - 12.000 mm
<b>MIN LENGTH OF BELT WITH NT</b>	1750 mm
<b>STANDARD COLOR</b>	White
<b>FDA/EU APPROVAL</b>	No
<b>POLYAMIDE FABRIC</b>	Optional NT

**MIN PULLEY DIAMETER:**  
50MM AT TEMPERATURES BELOW -5°

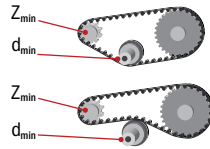

	STEEL
<b>z min</b>	10
<b>d min</b>	15,91
<b>z min</b>	15
<b>d min</b>	30

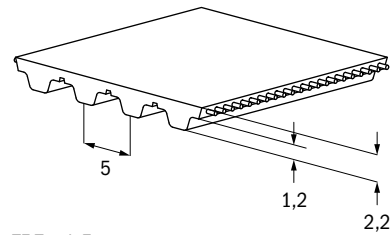

T5 Tooth Form

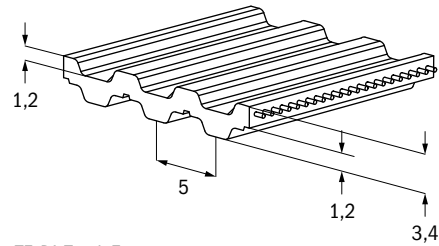

T5-DL Tooth Form

PRODUCT LINE	POLYURETHANE	HARDNESS [° SHORE A]	TEMPERATURE RANGE [° C]	FEATURE
Standard	R23	90	-5 to +70	
Synchro-Power Flex Polar	R23T	90	-30 to +50	Low Temperature

**TECHNICAL DATA**

STANDARD WIDTH (MM)	UNIT	10	16	25	32	50	75	100
<b>BREAKING FORCE / AVERAGE VALUE</b>								
Steel	[N]	1.250	2.000	3.375	4.250	6.875	10.375	13.875
<b>ALLOWABLE BELT FORCE</b>								
Steel	[N]	311	498	840	1.058	1.711	2.582	3.453
<b>ALLOWABLE EFFECTIVE FORCE / MINIMUM 12 TEETH IN MESH</b>								
	[N]	250	400	625	800	1.250	1.875	2.500
<b>BELT WEIGHT</b>								
Standard	[kg/m]	0,02	0,04	0,06	0,06	0,11	0,17	0,22
DL	[kg/m]	0,03	0,04	0,07	0,09	0,14	0,21	0,28
<b>SPECIFIC BELT STIFFNESS</b>								
Steel	[N]	77.778	124.444	210.000	264.444	427.778	645.556	863.333

# T10 / PITCH: 10MM

## PRODUCT SPECIFICATIONS

<b>PITCH</b>	10 mm
<b>SLEEVE WIDTH</b>	
LENGTH < 12000MM	150 mm
LENGTH > 12000MM	100 mm
<b>WIDTH TOLERANCE</b>	
< 50MM WIDTH	+0,50 mm
> 50MM WIDTH	+0,75 mm
<b>LENGTH RANGE</b>	1.520 - 22.900 mm
<b>MIN LENGTH OF BELT WITH NT</b>	1.750 mm
<b>STANDARD COLOR</b>	White
<b>FDA/EU APPROVAL</b>	No
<b>POLYAMIDE FABRIC</b>	Optional NT

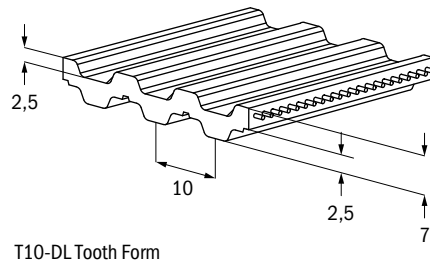
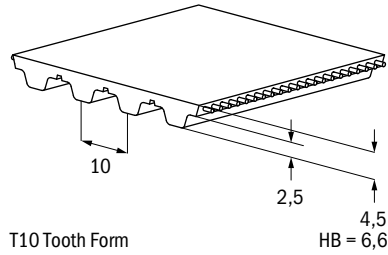

**MIN PULLEY DIAMETER:**  
50MM AT TEMPERATURES BELOW -5°

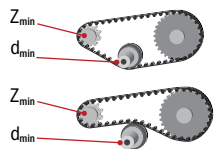

	STEEL/ARAMID	STEEL HF	NIRO	DL STEEL	DL STEEL HF	DL NIRO
<b>z min</b>	14	12	25	20	18	40
<b>d min</b>	45	38	80	64	57	130
<b>z min</b>	20	15	40	20	18	40
<b>d min</b>	80	60	130	64	57	130

PRODUCT LINE	POLYURETHANE	HARDNESS [° SHORE A]	TEMPERATURE RANGE [° C]	FEATURE
Standard	R23	90	-5 to +70	
Synchro-Power Flex Polar	R23T	90	-30 to +50	Low Temperature

## TECHNICAL DATA

STANDARD WIDTH (MM)	UNIT	16	25	32	50	75	100	150
<b>BREAKING FORCE / AVERAGE VALUE</b>								
Steel	[N]	4.200	7.140	9.240	14.700	22.260	29.820	44.940
Aramid	[N]	5.390	9.163	11.858	18.865	28.567	38.269	57.673
Steel HF	[N]	6.200	10.540	13.640	21.700	32.860	44.020	66.340
NIRO	[N]	3.400	5.780	7.480	11.900	18.020	24.140	36.380
<b>ALLOWABLE BELT FORCE</b>								
Steel	[N]	1.123	1.909	2.470	3.929	5.950	7.971	12.012
Aramid	[N]	704	1.196	1.548	2.463	3.730	4.997	7.531
Steel HF	[N]	1.376	2.340	3.028	4.818	7.295	9.773	14.728
NIRO	[N]	1.048	1.782	2.306	3.669	5.556	7.442	11.216
<b>ALLOWABLE EFFECTIVE FORCE / MINIMUM 12 TEETH IN MESH</b>								
	[N]	910	1.423	1.821	2.845	4.268	5.690	8.535
<b>BELT WEIGHT</b>								
Steel	[kg/m]	0,07	0,11	0,14	0,22	0,33	0,44	0,66
Aramid	[kg/m]	0,06	0,09	0,12	0,18	0,27	0,36	0,54
Steel HF	[kg/m]	0,08	0,12	0,15	0,24	0,35	0,47	0,71
NIRO	[kg/m]	0,07	0,11	0,14	0,22	0,34	0,45	0,67
DL Steel	[kg/m]	0,08	0,13	0,17	0,27	0,40	0,54	0,81
DL Aramid	[kg/m]	0,07	0,11	0,15	0,23	0,34	0,46	0,69
DL Steel HF	[kg/m]	0,09	0,14	0,18	0,28	0,43	0,57	0,85
DL NIRO	[kg/m]	0,08	0,13	0,17	0,27	0,40	0,54	0,81
<b>SPECIFIC BELT STIFFNESS</b>								
Steel	[N]	280.662	477.125	617.456	982.316	1.487.507	1.992.699	3.003.081
Aramid	[N]	175.946	299.109	387.082	615.813	932.516	1.249.220	1.882.627
Steel HF	[N]	344.118	585.000	757.059	1.204.412	1.823.824	2.443.235	3.682.059
NIRO	[N]	262.059	445.500	576.529	917.206	1.388.912	1.860.618	2.804.029

**T20 / PITCH: 20MM****PRODUCT SPECIFICATIONS**

<b>PITCH</b>	20 mm
<b>SLEEVE WIDTH</b>	
LENGTH < 12000MM	150 mm
LENGTH > 12000MM	100 mm
<b>WIDTH TOLERANCE</b>	+,-1,0 mm
<b>LENGTH RANGE</b>	1.520 - 22.900 mm
<b>MIN LENGTH OF BELT WITH NT</b>	1.760 mm
<b>STANDARD COLOR</b>	White
<b>FDA/EU APPROVAL</b>	No
<b>POLYAMIDE FABRIC</b>	Optional NT

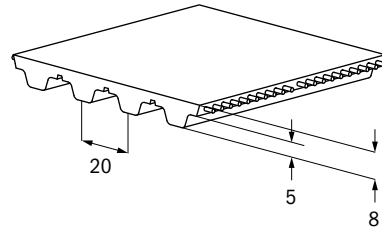
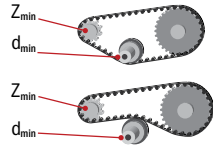
**MIN PULLEY DIAMETER:**

	STEEL	STEEL HF	NIRO
<b>z min</b>	15	12	20
<b>d min</b>	95	76	127
<b>z min</b>	18	15	25
<b>d min</b>	120	100	160

PRODUCT LINE	POLYURETHANE	HARDNESS [°SHORE A]	TEMPERATURE RANGE [°C]	FEATURE
Standard	R23	90	-5 to +70	
Synchro-Power Flex Polar	R23T	90	-30 to +50	Low Temperature

**TECHNICAL DATA**

STANDARD WIDTH (MM)	UNIT	25	32	50	75	100	150
<b>BREAKING FORCE / AVERAGE VALUE</b>							
Steel	[N]	14.250	18.050	29.450	44.650	59.850	90.250
Steel HF	[N]	12.975	16.435	26.815	40.655	54.495	82.175
NIRO	[N]	10.688	13.538	22.088	33.488	44.888	67.688
<b>ALLOWABLE BELT FORCE</b>							
Steel	[N]	3.741	4.739	7.731	11.722	15.712	23.693
Steel HF	[N]	3.456	4.378	7.142	10.829	14.515	21.888
NIRO	[N]	2.806	3.554	5.799	8.791	11.784	17.770
<b>ALLOWABLE EFFECTIVE FORCE / MINIMUM 12 TEETH IN MESH</b>							
	[N]	3.075	3.936	6.150	9.225	12.300	18.450
<b>BELT WEIGHT</b>							
Steel	[kg/m]	0,19	0,24	0,38	0,56	0,75	1,13
Steel HF	[kg/m]	0,18	0,23	0,36	0,54	0,72	1,08
NIRO	[kg/m]	0,19	0,24	0,37	0,56	0,74	1,11
<b>SPECIFIC BELT STIFFNESS</b>							
Steel	[N]	935.250	1.184.650	1.932.850	2.930.450	3.928.050	5.923.250
Steel HF	[N]	864.000	1.094.400	1.785.600	2.707.200	3.628.800	5.472.000
NIRO	[N]	701.438	888.488	1.449.638	2.197.838	2.946.038	4.442.438

# AT5 / PITCH: 5MM

## PRODUCT SPECIFICATIONS

<b>PITCH</b>	5 mm
<b>SLEEVE WIDTH</b>	100 mm
<b>WIDTH TOLERANCE</b>	
< 50MM WIDTH	+,-0,50 mm
> 50MM WIDTH	+,-0,75 mm
<b>LENGTH RANGE</b>	
AT5 STEEL	1.520 - 15.000 mm
AT5 STEEL HF	1.520 - 12.000 mm
<b>MIN LENGTH OF BELT WITH NT</b>	1.750 mm
<b>STANDARD COLOR</b>	White
<b>FDA/EU APPROVAL</b>	No
<b>POLYAMIDE FABRIC</b>	Optional NT

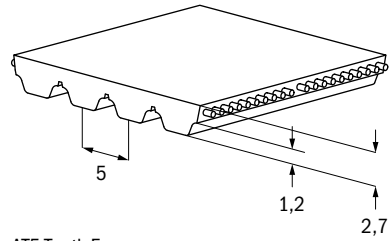

AT5 Tooth Form

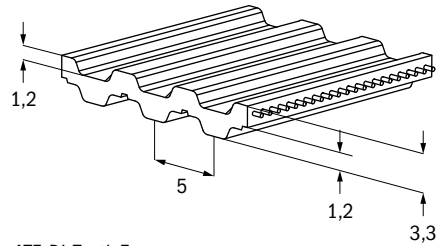

AT5-DL Tooth Form

**MIN PULLEY DIAMETER:**  
50MM AT TEMPERATURES BELOW -5°

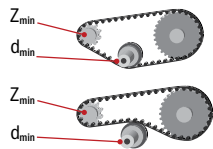

	STEEL	STEEL HF
<b>z min</b>	15	12
<b>d min</b>	24	19
<b>z min</b>	20	18
<b>d min</b>	60	50

PRODUCT LINE	POLYURETHANE	HARDNESS [ ° SHORE A]	TEMPERATURE RANGE [ ° C]	FEATURE
Standard	R23	90	-5 to +70	
Synchro-Power Flex Polar	R23T	90	-30 to +50	Low Temperature

## TECHNICAL DATA

STANDARD WIDTH (MM)	UNIT	10	16	25	32	50	75	100
<b>BREAKING FORCE / AVERAGE VALUE</b>								
Steel	[N]	2.565	4.275	7.125	9.120	14.535	21.945	29.355
Steel HF	[N]	2.640	4.400	7.480	9.680	15.400	23.320	31.240
<b>ALLOWABLE BELT FORCE</b>								
Steel	[N]	634	1.056	1.761	2.253	3.591	5.422	7.253
Steel HF	[N]	384	640	1.087	1.407	2.238	3.389	4.540
<b>ALLOWABLE EFFECTIVE FORCE / MINIMUM 12 TEETH IN MESH</b>								
	[N]	480	768	1.200	1.536	2.400	3.600	4.800
<b>BELT WEIGHT</b>								
Steel	[kg/m]	0,03	0,05	0,08	0,11	0,17	0,25	0,33
Steel HF	[kg/m]	0,03	0,05	0,08	0,11	0,17	0,25	0,33
DL Steel	[kg/m]	0,04	0,06	0,09	0,12	0,19	0,28	0,37
DL Steel HF	[kg/m]	0,04	0,06	0,09	0,12	0,19	0,28	0,37
<b>SPECIFIC BELT STIFFNESS</b>								
Steel	[N]	158.445	264.075	440.125	563.360	897.855	1.355.585	1.813.315
Steel HF	[N]	95.925	159.875	271.788	351.725	559.563	847.338	1.135.113

**ATL5 / PITCH: 5MM****PRODUCT SPECIFICATIONS**

<b>PITCH</b>	5 mm
<b>SLEEVE WIDTH</b>	100 mm
<b>WIDTH TOLERANCE</b>	
< 50MM WIDTH	+0,50 mm
> 50MM WIDTH	+0,75 mm
<b>LENGTH RANGE</b>	1.520 - 12.000 mm
<b>MIN LENGTH OF BELT WITH NT</b>	1.750 mm
<b>STANDARD COLOR</b>	White
<b>FDA/EU APPROVAL</b>	No
<b>POLYAMIDE FABRIC</b>	Optional NT

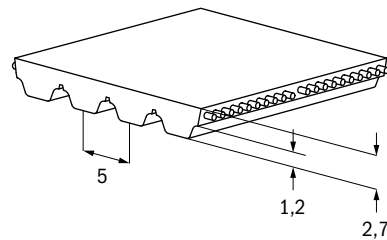
**MIN PULLEY DIAMETER:**

50MM AT TEMPERATURES BELOW -5°

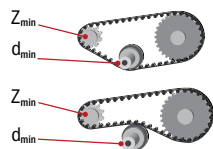

	STEEL
<b>z min</b>	15
<b>d min</b>	24
<b>z min</b>	20
<b>d min</b>	60

PRODUCT LINE	POLYURETHANE	HARDNESS [° SHORE A]	TEMPERATURE RANGE [° C]	FEATURE
Standard	R23	90	-5 to +70	
Synchro-Power Flex Polar	R23T	90	-30 to +50	Low Temperature

**TECHNICAL DATA**

STANDARD WIDTH (MM)	UNIT	10	16	25	32	50	75	100
<b>BREAKING FORCE / AVERAGE VALUE</b>								
Steel	[N]	3.720	6.200	10.540	13.640	21.700	32.860	44.020
<b>ALLOWABLE BELT FORCE</b>								
Steel	[N]	774	1.290	2.193	2.838	4.515	6.837	9.159
<b>ALLOWABLE EFFECTIVE FORCE / MINIMUM 12 TEETH IN MESH</b>								
	[N]	480	768	1.200	1.536	2.400	3.600	4.800
<b>BELT WEIGHT</b>								
Steel	[kg/m]	0,04	0,07	0,11	0,14	0,22	0,33	0,44
<b>SPECIFIC BELT STIFFNESS</b>								
Steel	[N]	193.500	322.500	548.250	709.500	1.128.750	1.709.250	2.289.750

# AT10 / PITCH: 10MM

## PRODUCT SPECIFICATIONS

<b>PITCH</b>	10 mm
<b>SLEEVE WIDTH</b>	
LENGTH < 12000MM	150 mm
LENGTH > 12000MM	100 mm
<b>WIDTH TOLERANCE</b>	
< 50MM WIDTH	+0,75 mm
> 50MM WIDTH	+1,0 mm
<b>LENGTH RANGE</b>	1.520 - 22.900 mm
<b>MIN LENGTH OF BELT WITH NT</b>	1.750 mm
<b>STANDARD COLOR</b>	White
<b>FDA/EU APPROVAL</b>	No
<b>POLYAMIDE FABRIC</b>	Optional NT

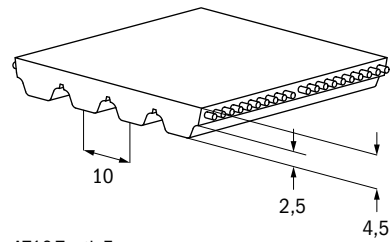

AT10 Tooth Form

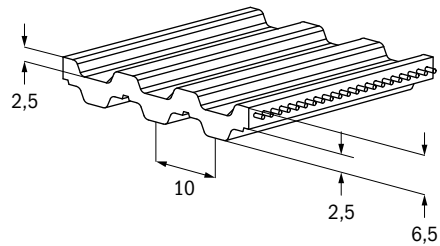

AT10-DL Tooth Form

**MIN PULLEY DIAMETER:**  
50MM AT TEMPERATURES BELOW -5°

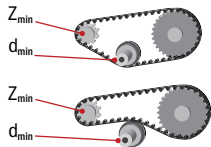

	STEEL	STEEL HF	NIRO
<b>z min</b>	15	12	25
<b>d min</b>	48	38	80
<b>z min</b>	20	15	40
<b>d min</b>	120	100	120

PRODUCT LINE	POLYURETHANE	HARDNESS [° SHORE A]	TEMPERATURE RANGE [° C]	FEATURE
Standard	R23	90	-5 to +70	
Synchro-Power Flex Polar	R23T	90	-30 to +50	Low Temperature

## TECHNICAL DATA

STANDARD WIDTH (MM)	UNIT	25	32	50	75	100	150
<b>BREAKING FORCE / AVERAGE VALUE</b>							
Steel	[N]	14.250	18.050	29.450	44.650	59.850	90.250
Steel HF	[N]	12.975	16.435	26.815	40.655	54.495	82.175
NIRO	[N]	10.688	13.538	22.088	33.488	44.888	67.668
<b>ALLOWABLE BELT FORCE</b>							
Steel	[N]	3.741	4.739	7.731	11.722	15.712	23.693
Steel HF	[N]	3.456	4.378	7.142	10.829	14.515	21.888
NIRO	[N]	2.806	3.554	5.799	8.791	11.784	17.770
<b>ALLOWABLE EFFECTIVE FORCE / MINIMUM 12 TEETH IN MESH</b>							
	[N]	2.580	3.302	5.160	7.740	10.320	15.480
<b>BELT WEIGHT</b>							
Steel	[kg/m]	0,14	0,18	0,29	0,43	0,57	0,86
Steel HF	[kg/m]	0,14	0,18	0,28	0,41	0,55	0,83
NIRO	[kg/m]	0,14	0,18	0,29	0,43	0,57	0,86
DL Steel	[kg/m]	0,19	0,24	0,37	0,56	0,75	1,13
DL Steel HF	[kg/m]	0,18	0,23	0,36	0,54	0,72	1,09
DL NIRO	[kg/m]	0,19	0,24	0,37	0,56	0,75	1,12
<b>SPECIFIC BELT STIFFNESS</b>							
Steel	[N]	935.250	1.184.650	1.932.850	2.930.450	3.928.050	5.923.250
Steel HF	[N]	864.000	1.094.400	1.785.600	2.707.200	3.628.800	5.472.000
NIRO	[N]	701.438	888.488	1.449.638	2.197.838	2.946.038	4.442.438

**ATL10 / PITCH: 10MM****PRODUCT SPECIFICATIONS**

<b>PITCH</b>	10 mm
<b>SLEEVE WIDTH</b>	
LENGTH < 12000MM	150 mm
LENGTH > 12000MM	100 mm
<b>WIDTH TOLERANCE</b>	
< 50MM WIDTH	+/-1,0 mm
> 50MM WIDTH	+/-1,5 mm
<b>LENGTH RANGE</b>	
ATL10 STEEL	1.520 - 22.900
ATL10 STEEL HF	1.520 - 12.000
<b>MIN LENGTH OF BELT WITH NT</b>	1.750 mm
<b>STANDARD COLOR</b>	White
<b>FDA/EU APPROVAL</b>	No
<b>POLYAMIDE FABRIC</b>	Optional NT

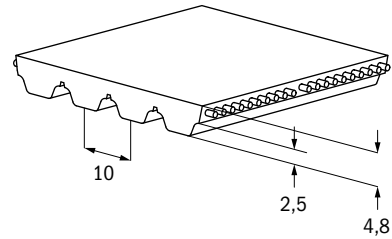
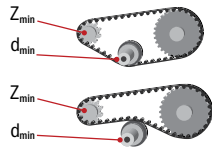
**MIN PULLEY DIAMETER:**

	STEEL	STEEL HF
<b>z min</b>	25	20
<b>d min</b>	80	64
<b>z min</b>	30	25
<b>d min</b>	150	130

PRODUCT LINE	POLYURETHANE	HARDNESS [° SHORE A]	TEMPERATURE RANGE [° C]	FEATURE
Standard	R23	90	-5 to +70	
Synchro-Power Flex Polar	R23T	90	-30 to +50	Low Temperature

**TECHNICAL DATA**

STANDARD WIDTH (MM)	UNIT	25	32	50	75	100	150
<b>BREAKING FORCE / AVERAGE VALUE</b>							
Steel	[N]	24.220	31.140	50.170	76.120	102.070	122.830
Steel HF	[N]	26.950	34.650	55.825	84.700	113.575	136.675
<b>ALLOWABLE BELT FORCE</b>							
Steel	[N]	5.860	7.534	12.139	18.417	24.696	32.780
Steel HF	[N]	5.079	6.530	10.521	15.963	21.404	25.758
<b>ALLOWABLE EFFECTIVE FORCE / MINIMUM 12 TEETH IN MESH</b>							
	[N]	2.580	3.302	5.160	7.740	10.320	15.480
<b>BELT WEIGHT</b>							
Steel	[kg/m]	0,17	0,21	0,34	0,50	0,67	1,01
Steel HF	[kg/m]	0,18	0,23	0,36	0,54	0,72	1,08
DL Steel	[kg/m]	0,21	0,19	0,30	0,45	0,61	0,87
DL Steel HF	[kg/m]	0,23	0,18	0,29	0,43	0,58	0,84
<b>SPECIFIC BELT STIFFNESS</b>							
Steel	[N]	1.465.000	1.883.571	3.034.643	4.604.286	6.173.929	7.429.643
Steel HF	[N]	1.269.750	1.632.536	2.630.196	3.990.643	5.351.089	6.439.446

**AT20 / PITCH: 20MM**

**PRODUCT SPECIFICATIONS**

<b>PITCH</b>	20 mm
<b>SLEEVE WIDTH</b>	
LENGTH < 12000MM	150 mm
LENGTH > 12000MM	100 mm
<b>WIDTH TOLERANCE</b>	
< 50MM WIDTH	+,-1,0 mm
> 50MM WIDTH	+,-1,5 mm
<b>LENGTH RANGE</b>	
AT20 STEEL	1.600 - 22.900 mm
AT20 STEEL HF	1.600 - 12.000 mm
<b>MIN LENGTH OF BELT WITH NT</b>	1.760 mm
<b>STANDARD COLOR</b>	White
<b>FDA/EU APPROVAL</b>	No
<b>POLYAMIDE FABRIC</b>	Optional NT

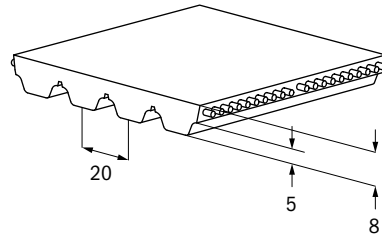

**MIN PULLEY DIAMETER:**

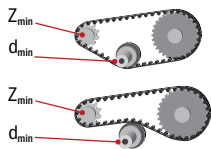

	STEEL	STEEL HF
<b>z min</b>	18	16
<b>d min</b>	115	102
<b>z min</b>	25	23
<b>d min</b>	180	150

PRODUCT LINE	POLYURETHANE	HARDNESS [ ° SHORE A]	TEMPERATURE RANGE [ ° C]	FEATURE
Standard	R23	90	-5 to +70	
Synchro-Power Flex Polar	R23T	90	-30 to +50	Low Temperature

**TECHNICAL DATA**

STANDARD WIDTH (MM)	UNIT	32	50	75	100	150
<b>BREAKING FORCE / AVERAGE VALUE</b>						
Steel	[N]	31.140	50.170	76.120	102.070	128.020
Steel HF	[N]	34.650	55.825	84.700	113.575	171.325
<b>ALLOWABLE BELT FORCE</b>						
Steel	[N]	7.534	12.139	18.417	24.696	30.974
Steel HF	[N]	5.659	9.432	14.337	19.242	29.052
<b>ALLOWABLE EFFECTIVE FORCE / MINIMUM 12 TEETH IN MESH</b>						
	[N]	6.976	10.900	16.350	21.800	32.700
<b>BELT WEIGHT</b>						
Steel	[kg/m]	0,31	0,49	0,73	0,97	1,46
Steel HF	[kg/m]	0,32	0,51	0,76	1,01	1,52
<b>SPECIFIC BELT STIFFNESS</b>						
Steel	[N]	1.883.571	3.034.643	4.604.286	6.173.929	7.743.571
Steel HF	[N]	1.632.536	2.630.196	3.990.643	5.351.089	6.711.536



**ATL20 / PITCH: 20MM****PRODUCT SPECIFICATIONS**

<b>PITCH</b>	20 mm
<b>SLEEVE WIDTH</b>	
LENGTH < 12000MM	150 mm
LENGTH > 12000MM	100 mm
<b>WIDTH TOLERANCE</b>	+,-2,0 mm
<b>LENGTH RANGE</b>	1.520 - 22.900.mm
<b>MIN LENGTH OF BELT WITH NT</b>	1.760 mm
<b>STANDARD COLOR</b>	White
<b>FDA/EU APPROVAL</b>	No
<b>POLYAMIDE FABRIC</b>	Optional NT

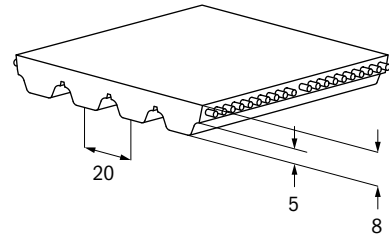
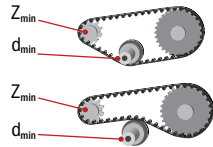
**MIN PULLEY DIAMETER:**

	STEEL	STEEL NIRO
<b>z min</b>	25	26
<b>d min</b>	160	166
<b>z min</b>	30	32
<b>d min</b>	250	260

PRODUCT LINE	POLYURETHANE	HARDNESS [°SHORE A]	TEMPERATURE RANGE [°C]	FEATURE
Standard	R23	90	-5 to +70	
Synchro-Power Flex Polar	R23T	90	-30 to +50	Low Temperature

**TECHNICAL DATA**

STANDARD WIDTH (MM)	UNIT	32	50	75	100	150
<b>BREAKING FORCE / AVERAGE VALUE</b>						
Steel	[N]	41.600	70.400	105.600	144.000	227.200
NIRO	[N]	22.500	38.250	58.500	78.750	121.500
<b>ALLOWABLE BELT FORCE</b>						
Steel	[N]	9.106	15.410	23.115	31.520	49.732
NIRO	[N]	6.110	10.388	15.887	21.386	32.996
<b>ALLOWABLE EFFECTIVE FORCE / MINIMUM 12 TEETH IN MESH</b>						
	[N]	6.976	10.900	16.350	21.800	32.700
<b>BELT WEIGHT</b>						
Steel	[kg/m]	0,35	0,54	0,81	1,08	1,62
NIRO	[kg/m]	0,34	0,53	0,80	1,06	1,59
<b>SPECIFIC BELT STIFFNESS</b>						
Steel	[N]	2.276.477	3.852.500	5.778.750	7.880.114	12.433.067
NIRO	[N]	1.527.600	2.596.920	3.971.760	5.346.600	8.249.040

**HTD5 / PITCH: 5MM**

**PRODUCT SPECIFICATIONS**

<b>PITCH</b>	5 mm
<b>SLEEVE WIDTH</b>	100 mm
<b>WIDTH TOLERANCE</b>	
< 50MM WIDTH	+,-0,50 mm
> 50MM WIDTH	+,-0,75 mm
<b>LENGTH RANGE</b>	1.520 - 15.000 mm
<b>MIN LENGTH OF BELT WITH NT</b>	1.750
<b>STANDARD COLOR</b>	White
<b>FDA/EU APPROVAL</b>	No
<b>POLYAMIDE FABRIC</b>	Optional NT

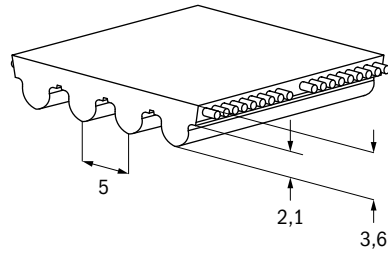

**MIN PULLEY DIAMETER:**  
50MM AT TEMPERATURES BELOW -5°

	STEEL
<b>z min</b>	16
<b>d min</b>	25
<b>z min</b>	20
<b>d min</b>	80

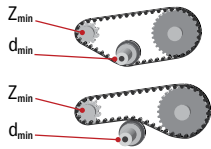

PRODUCT LINE	POLYURETHANE	HARDNESS [° SHORE A]	TEMPERATURE RANGE [° C]	FEATURE
Standard	R23	90	-5 to +70	
Synchro-Power Flex Polar	R23T	90	-30 to +50	Low Temperature

**TECHNICAL DATA**

STANDARD WIDTH (MM)	UNIT	25	50	75	100
<b>BREAKING FORCE / AVERAGE VALUE</b>					
Steel	[N]	7.125	14.535	21.945	29.355
<b>ALLOWABLE BELT FORCE</b>					
Steel	[N]	1.761	3.591	5.422	7.253
<b>ALLOWABLE EFFECTIVE FORCE / MINIMUM 12 TEETH IN MESH</b>					
	[N]	1.125	2.250	3.375	4.500
<b>BELT WEIGHT</b>					
Steel	[kg/m]	0,11	0,22	0,33	0,44
<b>SPECIFIC BELT STIFFNESS</b>					
Steel	[N]	440.125	897.855	1.355.585	1.813.315

**HTDL5 / PITCH: 5MM****PRODUCT SPECIFICATIONS**

<b>PITCH</b>	5 mm
<b>SLEEVE WIDTH</b>	100 mm
<b>WIDTH TOLERANCE</b>	
< 50MM WIDTH	+0,50 mm
> 50MM WIDTH	+0,75 mm
<b>LENGTH RANGE</b>	1.520 - 12.000 mm
<b>MIN LENGTH OF BELT WITH NT</b>	1.750
<b>STANDARD COLOR</b>	White
<b>FDA/EU APPROVAL</b>	No
<b>POLYAMIDE FABRIC</b>	Optional NT

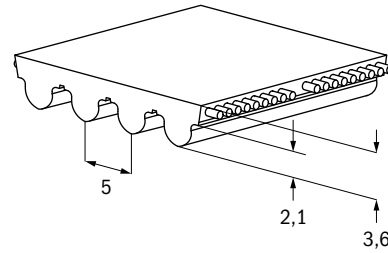
**MIN PULLEY DIAMETER:**

50MM AT TEMPERATURES BELOW -5°

		STEEL
$z_{min}$	$z_{min}$	14
$d_{min}$	$d_{min}$	22
$z_{min}$	$z_{min}$	18
$d_{min}$	$d_{min}$	60

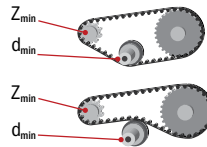

PRODUCT LINE	POLYURETHANE	HARDNESS [°SHORE A]	TEMPERATURE RANGE [°C]	FEATURE
Standard	R23	90	-5 to +70	
Synchro-Power Flex Polar	R23T	90	-30 to +50	Low Temperature

**TECHNICAL DATA**

STANDARD WIDTH (MM)	UNIT	25	50	75	100
<b>BREAKING FORCE / AVERAGE VALUE</b>					
Steel	[N]	10.540	21.700	32.860	44.020
<b>ALLOWABLE BELT FORCE</b>					
Steel	[N]	2.340	4.818	7.295	9.773
<b>ALLOWABLE EFFECTIVE FORCE / MINIMUM 12 TEETH IN MESH</b>					
	[N]	1.125	2.250	3.375	4.500
<b>BELT WEIGHT</b>					
Steel	[kg/m]	0,12	0,25	0,37	0,49
<b>SPECIFIC BELT STIFFNESS</b>					
Steel	[N]	585.000	1.204.412	1.823.824	2.443.235

# HTD8 / PITCH: 8MM

## PRODUCT SPECIFICATIONS

<b>PITCH</b>	8 mm
<b>SLEEVE WIDTH</b>	
LENGTH < 12000MM	150 mm
LENGTH > 12000MM	100 mm
<b>WIDTH TOLERANCE</b>	
< 50MM WIDTH	+0,75 mm
> 50MM WIDTH	+1,0 mm
<b>LENGTH RANGE</b>	1.520 - 22.800 mm
<b>MIN LENGTH OF BELT WITH NT</b>	1.752 mm
<b>STANDARD COLOR</b>	White
<b>FDA/EU APPROVAL</b>	No
<b>POLYAMIDE FABRIC</b>	Optional NT

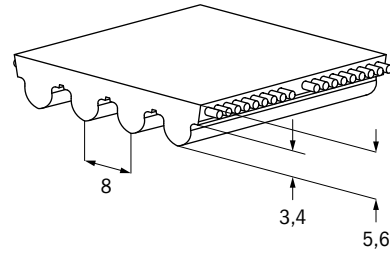

**MIN PULLEY DIAMETER:**  
50MM AT TEMPERATURES BELOW -5°

	STEEL	STEEL HF	NIRO
<b>z min</b>	18	16	25
<b>d min</b>	46	41	64
<b>z min</b>	20	18	30
<b>d min</b>	120	100	150

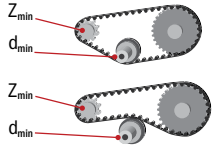

PRODUCT LINE	POLYURETHANE	HARDNESS [°SHORE A]	TEMPERATURE RANGE [°C]	FEATURE
Standard	R23	90	-5 to +70	
Synchro-Power Flex Polar	R23T	90	-30 to +50	Low Temperature

## TECHNICAL DATA

STANDARD WIDTH (MM)	UNIT	20	25	30	50	85	100	150
<b>BREAKING FORCE / AVERAGE VALUE</b>								
Steel	[N]	10.450	14.250	17.100	29.450	50.350	59.850	90.250
Steel HF	[N]	9.515	12.975	15.570	26.815	45.845	54.495	82.175
NIRO	[N]	7.838	10.688	12.825	22.088	37.763	44.888	67.688
<b>ALLOWABLE BELT FORCE</b>								
Steel	[N]	2.743	3.741	4.489	7.731	13.218	15.712	23.693
Steel HF	[N]	2.534	3.456	4.147	7.142	12.211	14.515	21.888
NIRO	[N]	2.058	2.806	3.367	5.799	9.914	11.784	17.770
<b>ALLOWABLE EFFECTIVE FORCE / MINIMUM 12 TEETH IN MESH</b>								
	[N]	1.860	2.325	2.790	4.650	7.905	9.300	13.950
<b>BELT WEIGHT</b>								
Steel	[kg/m]	0,14	0,17	0,21	0,35	0,59	0,69	1,04
Steel HF	[kg/m]	0,13	0,17	0,20	0,33	0,56	0,66	0,99
NIRO	[kg/m]	0,14	0,17	0,20	0,34	0,58	0,68	1,02
<b>SPECIFIC BELT STIFFNESS</b>								
Steel	[N]	685.850	935.250	1.122.300	1.932.850	3.304.550	3.928.050	5.923.250
Steel HF	[N]	633.600	864.000	1.036.800	1.785.600	3.052.800	3.628.800	5.472.000
NIRO	[N]	514.388	701.438	841.725	1.449.638	2.478.413	2.946.038	4.442.438

**HTD14 / PITCH: 14MM****PRODUCT SPECIFICATIONS**

<b>PITCH</b>	14 mm
<b>SLEEVE WIDTH</b>	
LENGTH < 12000MM	170 mm
LENGTH > 12000MM	100 mm
<b>WIDTH TOLERANCE</b>	
< 50MM WIDTH	+,-1,0 mm
> 50 TO 100MM WIDTH	+,-1,5 mm
> 100MM WIDTH	+,-2,0 mm
<b>LENGTH RANGE</b>	
HTD14 STEEL	1.526 - 22.890 mm
HTD14 STEEL HF	1.526 - 11.998 mm
<b>MIN LENGTH OF BELT WITH NT</b>	1.750 mm
<b>STANDARD COLOR</b>	White
<b>FDA/EU APPROVAL</b>	No
<b>POLYAMIDE FABRIC</b>	Optional NT

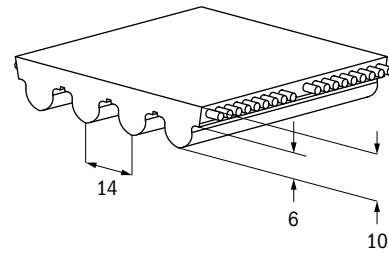
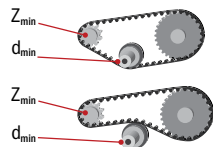
**MIN PULLEY DIAMETER:**

	STEEL	STEEL HF
<b>z min</b>	28	23
<b>d min</b>	125	103
<b>z min</b>	28	23
<b>d min</b>	200	160

PRODUCT LINE	POLYURETHANE	HARDNESS [°SHORE A]	TEMPERATURE RANGE [°C]	FEATURE
Standard	R23	90	-5 to +70	
Synchro-Power Flex Polar	R23T	90	-30 to +50	Low Temperature

**TECHNICAL DATA**

STANDARD WIDTH (MM)	UNIT	25	40	55	85	115	170
<b>BREAKING FORCE / AVERAGE VALUE</b>							
Steel	[N]	19.030	31.140	43.250	67.470	93.420	138.400
Steel HF	[N]	21.175	34.650	48.125	75.075	103.950	154.000
<b>ALLOWABLE BELT FORCE</b>							
Steel	[N]	5.156	8.437	11.718	18.280	25.311	37.498
Steel HF	[N]	4.470	7.314	10.158	15.846	21.941	32.506
<b>ALLOWABLE EFFECTIVE FORCE / MINIMUM 12 TEETH IN MESH</b>							
	[N]	4.313	6.900	9.488	14.663	19.838	29.325
<b>BELT WEIGHT</b>							
Steel	[kg/m]	0,27	0,43	0,59	0,92	1,24	1,84
Steel HF	[kg/m]	0,28	0,44	0,61	0,94	1,28	1,89
<b>SPECIFIC BELT STIFFNESS</b>							
Steel	[N]	1.289.000	2.109.273	2.929.545	4.570.091	6.327.818	9.374.545
Steel HF	[N]	1.117.380	1.828.440	2.539.500	3.961.620	5.485.320	8.126.400

**H / PITCH: 0,500"**

**PRODUCT SPECIFICATIONS**

<b>PITCH</b>	12,7 mm
<b>SLEEVE WIDTH</b>	
LENGTH < 12000MM	152,4 mm
LENGTH > 12000MM	101,6 mm
<b>WIDTH TOLERANCE</b>	
< 50MM WIDTH	+0,51 mm
> 50MM WIDTH	+0,76 mm
<b>LENGTH RANGE</b>	
H STEEL	1.524 - 22.900 mm
H STEEL HF	1.600,2 - 12.000 mm
<b>MIN LENGTH OF BELT WITH NT</b>	1.752,6 mm
<b>STANDARD COLOR</b>	White
<b>FDA/EU APPROVAL</b>	No
<b>POLYAMIDE FABRIC</b>	Optional NT

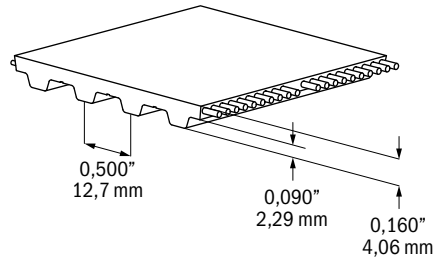

**MIN PULLEY DIAMETER:**

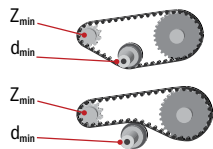

	STEEL	STEEL HF
<b>z min</b>	14	12
<b>d min</b>	57	49
<b>z min</b>	20	15
<b>d min</b>	80	60

PRODUCT LINE	POLYURETHANE	HARDNESS [ ° SHORE A]	TEMPERATURE RANGE [ ° C]	FEATURE
Standard	R23	90	-5 to +70	
Synchro-Power Flex Polar	R23T	90	-30 to +50	Low Temperature

**TECHNICAL DATA**

STANDARD WIDTH INCH (MM)	UNIT	0,5" (12,7MM)	0,75" (19,05MM)	1" (25,4MM)	1,5" (38,1MM)	2" (50,8MM)	3" (76,2MM)	4" (101,6MM)	6" (152,4MM)
<b>BREAKING FORCE / AVERAGE VALUE</b>									
Steel	[N]	3.360	5.040	7.140	10.920	14.700	22.260	29.820	44.940
Steel HF	[N]	4.960	7.440	10.540	16.120	21.700	32.860	44.020	66.340
<b>ALLOWABLE BELT FORCE</b>									
Steel	[N]	898	1.347	1.909	2.919	3.929	5.950	7.971	12.012
Steel HF	[N]	1.101	1.652	2.340	3.579	4.818	7.295	9.773	14.728
<b>ALLOWABLE EFFECTIVE FORCE / MINIMUM 12 TEETH IN MESH</b>									
	[N]	825	1.238	1.650	2.475	3.300	4.950	6.600	9.900
<b>BELT WEIGHT</b>									
Steel	[kg/m]	0,051	0,076	0,102	0,152	0,203	0,305	0,406	0,610
Steel HF	[kg/m]	0,055	0,082	0,109	0,164	0,218	0,328	0,437	0,655
<b>SPECIFIC BELT STIFFNESS</b>									
Steel	[N]	224.529	336.794	477.125	729.721	982.316	1.487.507	1.992.699	3.003.081
Steel HF	[N]	275.294	412.941	585.000	894.706	1.204.412	1.823.824	2.443.235	3.682.059



# ENDLESS WELDED OR TRULY ENDLESS?

## CONVEYING OR POWER TRANSMISSION APPLICATION?

### ENDLESS WELDED BELT FOR MOST CONVEYING APPLICATIONS

The weld has appr. 50 % of open ended belt strength.

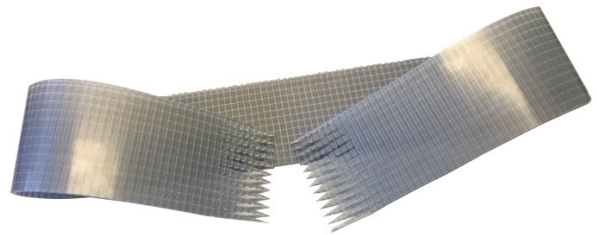

### TRULY ENDLESS BELT FOR ROTARY POSITIONING OR LIGHT POWER TRANSMISSION APPLICATIONS

#### TRULY ENDLESS BELT OFFER 100% TENSILE STRENGTH

- Synchro-Power Sleeve for length from 120 to 2250 mm
- Synchro-Power Flex for length from 1,5 to 22,9 m

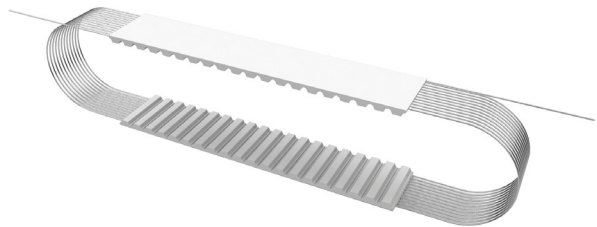

# BACKINGS

## TIMING BELTS

Gates TPU offers infinite design possibilities for both open-ended and endless timing belts from over 30 different backing material options. Most belt types can be modified by adding a backing to achieve a desired coefficient of friction, abrasion resistance or cushion. Additional surface finishing achieves the required characteristic for many applications. From ground edges or surfaces and tight tolerances to punching or machining holes and slots and CNC machining of 3-dimensional contours, Gates TPU provides a range of customized solutions.

### FABRICATION POSSIBILITIES

**WE PROVIDE AN EXTENSIVE RANGE OF FABRICATION POSSIBILITIES, TO INCLUDE COUNTLESS COMBINATIONS OF BACKINGS IN VARIOUS MATERIAL, THICKNESS AND DIMENSIONS, THAT IS AVAILABLE UPON REQUEST.**



### ATTRIBUTES

- Increase or decrease in the coefficient of friction
- Various levels of cushioning and durability
- Chemical resistance
- Oil & fat resistance
- Available with FDA/EU food approval



### APPLICATIONS

- Glass & Ceramics
- Packaging
- Stone processing industry
- Cardboard transport
- Wood processing industry
- Packaging industry
- Feeding and pulling applications
- Ascending conveyors

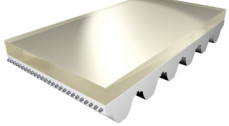

## POLYURETHANE BACKINGS

Polyurethane is the most abrasion-proof, resilient and durable backing - with a variety of thickness & hardness selections available, we offer options to suit your application. Polyurethane backings are thermally bonded onto the belts to ensure a strong bond to the base belt for enhanced durability.

MATERIAL	COLOR	HARDNESS	MATERIAL THICKNESS	MINIMUM PULLEY DIAMETER FACTOR	NAME	BACKING
PU	Clear	85 ShoreA	2 mm/3 mm	x 30	Taracx 85	
PU	Orange	60 ShoreA	2 mm/3 mm/6 mm	x 20	Taracx 60	
PU	Green	50 ShoreA	2 mm/3 mm	x 20	Taracx 50	
PU	White	92 ShoreA	2 mm/3 mm	x 30	Polyurethane White	
PU	Clear	85 ShoreA	5 mm	Ø 120	Glass Backing	
PU	Clear	85 ShoreA	3 mm	Ø 90	Ridge Top	
PU	Clear	85 ShoreA	1 mm/2 mm	x 30	HV Foil	
PU	Clear	85 ShoreA 95 ShoreA	2,7 mm	Ø 75	Fine Glass Backing	

# RUBBER BACKINGS

Rubber backings deliver a high coefficient of friction, temperature resistance, and are commonly used within wood processing, glass processing, and ceramics industries. Rubber backings are applied by adhesive bonding to suit the material characteristics.

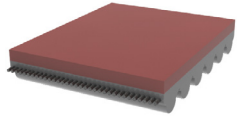
MATERIAL	COLOR	HARDNESS	MATERIAL THICKNESS	MINIMUM Ø/ Ø FACTOR	NAME	BACKING
NATURAL RUBBER	Red	38 Shore A	1,6 mm up to 10 mm *	x 20	Linatex™	
NATURAL RUBBER (FDA Approved)	White	38 Shore A	3 mm 5 mm 8 mm *	x 20	Linaplus FG™	
NATURAL RUBBER	Beige	40 Shore A	3 mm 6 mm *	x 20	Tan Natural Rubber	
NATURAL RUBBER	Black	65 Shore A	3 mm 5 mm 6 mm *	x 25	Nitrile Rubber	
NATURAL RUBBER	Orange	55 Shore A	3 mm 8 mm *	x 20	Linatrile™	
NATURAL RUBBER	Yellow	38 Shore A	2 mm 4 mm *	x 20	RP400	

\* Several layers can be bonded together or ground for other thicknesses.

## FOAM BACKINGS

Foam Backings provide high flexibility and are commonly used within glass, paper, textile, and wood processing industries. Foam Backings are applied by adhesive bonding.

MATERIAL	COLOR	HARDNESS	MATERIAL THICKNESS	MINIMUM Ø/ Ø FACTOR	NAME	BACKING
HIGH DENSITY POLYURETHANE FOAM	Yellow	55 Shore A	2 mm up to 8 mm *	x 30	HD Yellow	
POLYURETHANE FOAM	Yellow	160 kg/m <sup>3</sup>	12 mm *	x 15	Sylomer™ Yellow	
POLYURETHANE FOAM	Blue	220 kg/m <sup>3</sup>	12 mm 25 mm *	x 15	Sylomer Blue	
POLYURETHANE FOAM	Green	300 kg/m <sup>3</sup>	6 mm 12 mm 25 mm *	x 15	Sylomer Green	
FOAMED POLYURETHANE	Brown	400 kg/m <sup>3</sup>	6 mm 12 mm 25 mm *	x 15	Sylomer Brown	
POLYURETHANE FOAM	Red	500 kg/m <sup>3</sup>	6 mm 12 mm 25 mm *	x 15	Sylomer Red	
CELLULAR RUBBER	Black	150-200 kg/m <sup>3</sup>	3 mm 5 mm 10 mm *	x 15	Neoprene	
NATURAL POLYURETHANE FOAM (High Flexibility)	Beige / Yellow	400 kg/m <sup>3</sup>	3 mm up to 8 mm *	x 15	Natural	

\* Several layers can be bonded together or ground for other thicknesses.

## PVC BACKINGS



Polyvinylchlorid (PVC) Backings are commonly used in glass and wood processing, ceramic and packaging industries. Due to various FDA / EU approvals, PVC Backings are allowed within food processing or industry applications requiring high hygiene. PVC backings are applied by adhesive bonding.

MATERIAL	COLOR	HARDNESS	MATERIAL THICKNESS	MINIMUM Ø/ Ø FACTOR	NAME	BACKING
PVC	Green	46 Shore A	4,8 mm	90 mm	Rough Top	
PVC (FDA / EU approved)	White	65 Shore A	1,2 mm*	25 mm	Small Pebbles Structure	
PVC (FDA / EU approved)	White	35 Shore A	6 mm	40 mm	Large Pebbles Structure	
PVC (FDA / EU approved)	White	70 Shore A	4,5 mm	90 mm	PVC Herringbone	
PVC (FDA / EU approved)	White	40 Shore A	2,5 mm	90 mm	PVC Saw Tooth	
PVC (FDA / EU approved)	White	65 Shore A	0,7 mm	50 mm	PVC Waffle Structure	
PVC	Blue	60 Shore A	1 mm 2 mm	40 mm	PVC Blue	
PVC (FDA / EU approved)	White	65 Shore A	2 mm	40 mm	PVC White	

## SPECIAL BACKINGS + FABRIC

### SPECIAL BACKINGS

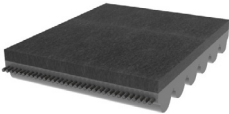
Gates offers additional special backings such as Novo Fleece and Chrome Leather. All special backings are applied by adhesive bonding.

MATERIAL	COLOR	HARDNESS	MATERIAL THICKNESS	MINIMUM Ø	ATTRIBUTES	NAME	NAME	BACKING
POLYESTER	Anthracite	Not Measurable	1,2 mm	25 mm	Suited for high temp ranges Oil/fat resistance	General Conveying Applications Glass Processing	Novo Fleece	
LEATHER	Grey	65 Shore A	2 mm 3 mm	90 mm	High coefficient of friction Abrasion resistance Oil resistance	General Conveying Applications	Chrome Leather	

### FABRIC

Polyamide fabric reduces the coefficient of friction to provide smooth & enhanced operating characteristics.

#### APPLICATIONS

- Accumulating conveyor
- Sliding applications

#### ATTRIBUTES

- Low coefficient of friction
- High wear resistance
- Good sliding attributes
- Low-noise operation
- Oil/fat resistance

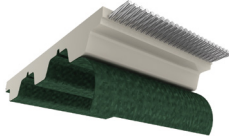
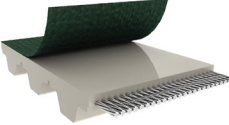
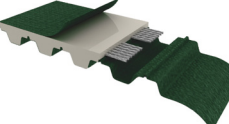
MATERIAL	COLOR	CODE	BACKING
POLYAMID FABRIC ON TOOTH SIDE	Green	NT	
POLYAMID FABRIC ON BACK SIDE	Green	NB	
POLYAMID FABRIC ON BACK SIDE	Green	NTB	



# PROFILE BELTS

Gates TPU (Thermoplastic Polyurethane) Belts can be customized with welded profiles to meet specific application requirements. The molded profiles are made of tough polyurethane and become an integral part of the belt through thermal bonding. Profiles can be manufactured in nearly any shape and construction.

Our timing belts with welded profiles are optimal for applications in packaging, general conveying and other automation equipment applications.

**CHOOSE FROM OVER 2 000 EXISTING PROFILES AVAILABLE FROM GATES' EXTENSIVE MOLD INVENTORY.**

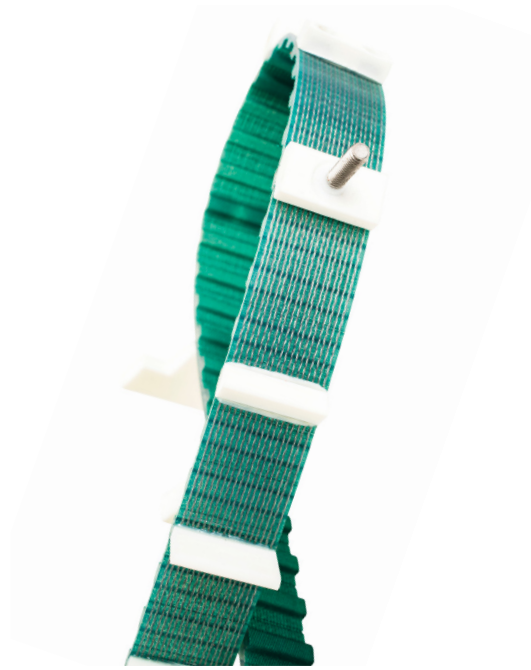

## ATTRIBUTES

- Available for all standard pitches
- Non-marking, durable design
- Over 2 000 existing shapes and constructions
- Widths up to 18" / 450 mm available
- Thermal bonding process fuses belt and profile together

## APPLICATIONS

- Pushing applications
- General conveying applications
- Glass conveying
- Food conveying
- Hygienic industry
- Textile industry
- Wood processing industry
- Synchronous conveying applications

## FABRICATION CAPABILITIES

- Minimum length: 500 mm
- Maximum length: 25 000 mm
- Maximum width: 450 mm / 18"

Special dimensions and tolerances are available on request.



## PROFILE BELT DESIGN RECOMMENDATIONS

Over 2.000 profile designs are already available from Gates' extensive mold inventory. On our website, the Gates TPU Belt Profile Selector helps to find the profile for your application. If none of the existing profiles fit, our application engineers will help you to design new, custom built profiles which will fit your application.

Ultimate performance can be achieved by following the design guidelines outlined below:

### 1. PROFILE SPACING

It is recommended that the profile spacing "A" correspond with the pitch of the belt. This allows the best spacing tolerances, and minimizes the effects of the belt's overall length tolerance on the profile spacing. Profiles can be spaced on non-Pitch increments. However, if non-Pitch spacing is used, the cumulative tolerance of the belt length must be considered.

**PLEASE ADD THE PROFILE SPACING TOLERANCE OF  $\pm 0.2$  MM TO CALCULATE THE PROFILE SPACING "A" AS FOLLOWS:**

#### EXAMPLE

Profile Spacing Tolerance for pitch type T10:	$\pm 0,54$ mm
Profile Spacing "A" (notional value):	1.000 mm
Resultant positional tolerance:	1.000 mm $\pm 0,74$ mm for pitch type T10

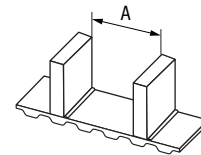

**TIGHTER TOLERANCES FOR PROFILE SPACING ARE AVAILABLE.  
PLEASE CONTACT GATES APPLICATIONS ENGINEERING FOR DETAILED INFORMATION.**

#### PITCH TOLERANCE FOR ALL BELT TYPES

T / STD / Imperial Pitches	$\pm 0,54$ mm perm
AT / HTD / GPP / HPL	+ 0,27 mm / - 0,54 mm per m

### 2. PROFILE DIMENSIONS

The most important considerations while dimensioning a profile are the size of the base of the profile ("foot" of the profile) and the position of the profile on the belt. The profile thickness can affect the flexibility of the belt, and can determine the minimum allowable pulley diameter. The flexibility of the belt can be maximized, however, by positioning the profile directly over the tooth of the belt. As the thickness of the foot of the profile increases, the minimum pulley diameter in the system must be increased according to the table below:

#### TOLERANCES

Profile Width	$\pm 0,25$ mm / $\pm 0,01$ "
Profile Length	$\pm 0,25$ mm / $\pm 0,01$ "
The height tolerance of a profile in consequence of the fusion of the profile and belt at the welding area	+0,25 mm / - 0,5 mm + 0,01" / - 0,02"



### MINIMUM NUMBER OF TEETH OF PULLEY FOR PROFILES LOCATED OVER TOOTH

PROFILE FOOT THICKNESS (MM)	2	3	5	6	8	10	11	13	16	19
PROFILE FOOT THICKNESS (INCH)	1/16	1/8	3/16	1/4	5/16	3/8	7/16	1/2	5/8	3/4
XL	10	10	18	25	40	50	60	100	---	---
L	12	12	12	18	30	40	50	60	100	---
H / H-HF	14	14	14	14	18	25	35	45	80	100
XH	18	18	18	18	18	18	18	20	35	50
T5	12	12	18	25	40	50	60	100	---	---
AT5 / ATL5	15	15	18	25	40	50	60	100	---	---
T10 / T10-HF	14	14	16	16	18	25	35	45	80	100
AT10	15	15	18	18	22	25	35	45	80	100
ATL10 / ATL10-HF	25	25	25	25	25	25	35	45	80	100
T20 / AT20	18	18	18	18	18	18	18	20	35	50
ATL20	30	30	30	30	30	30	30	30	35	50
HTD5 / STD5 / HPL5	14	14	16	25	40	50	60	100	---	---
HTD8 / STD8 / HPL8 / GPP8	20	20	20	24	30	40	50	60	100	---
HTD14	28	28	28	28	28	28	30	30	50	72
HTDL14 / GPP14	43	43	43	43	43	43	43	43	50	72

### MINIMUM NUMBER OF TEETH OF PULLEY FOR PROFILES NOT LOCATED OVER TOOTH

PROFILE FOOT THICKNESS (MM)	2	3	5	6	8	10	11	13	16	19
PROFILE FOOT THICKNESS (INCH)	1/16	1/8	3/16	1/4	5/16	3/8	7/16	1/2	5/8	3/4
XL	12	30	45	50	60	100	---	---	---	---
L	12	20	40	45	55	60	70	80	100	---
H / H-HF	14	14	25	30	45	50	55	65	80	100
XH	18	18	20	30	40	45	50	54	58	60
T5	12	30	45	50	60	100	---	---	---	---
AT5 / ATL5	15	30	45	50	60	100	---	---	---	---
T10 / T10-HF / AT10	18	20	30	40	45	50	55	65	80	100
ATL10 / ATL10-HF	25	25	30	40	45	50	55	65	80	100
T20 / AT20	18	18	20	30	40	45	50	54	58	60
ATL20	30	30	30	30	40	45	50	54	58	60
HTD5 / STD5 / HPL5	18	30	45	50	60	100	---	---	---	---
HTD8 / STD8 / HPL8 / GPP8	20	20	40	45	55	60	70	80	100	---
HTD14	28	28	30	42	58	64	72	78	82	86
HTDL14 / GPP14	43	43	43	43	58	64	72	78	82	86

\* Not available





### 3. PROFILE STRENGTH

The strength, and therefore the capacity of the profile depends primarily on the size of the welded profile foot. The strength of the profile is affected by the type and direction of the force applied to it. Under high loads, the failure mode will normally be either bending or distortion of the profile and belt, or in some cases, the polyurethane may actually tear. The strength of the profile is approximately 6 N/mm<sup>2</sup> according to the drawing opposite.

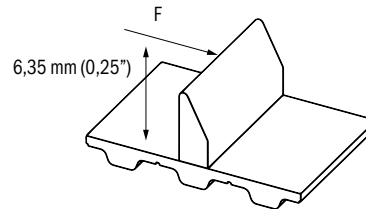

### 4. WIDE BASE PROFILES OR PROFILES WITH RELIEF

For profiles requiring a wide base, such as pushers, one foot should be left unwelded. This allows for flexing around the pulley yet it remains rigid when loaded.

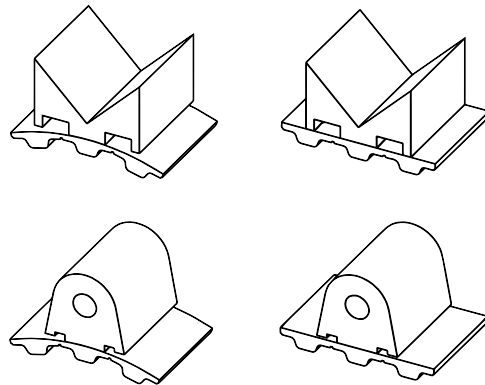

### 5. SEGMENTED PROFILES

If large profiles are required as carriers, then it is necessary, that they are either segmented or slotted.

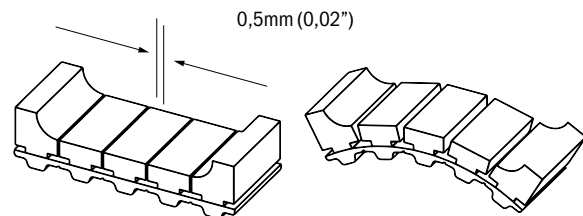

### 6. PROFILES WITH HOLES

Profiles with holes for securing paddles or other attachments can be produced. Holes are either drilled before bonding, or are molded into the profile depending upon the volume and requirements of the application. Tolerances of the hole placement depends upon whether the holes are drilled or molded.

The tolerance of the hole from the belt surface is subject to the bonding process of the profile foot and the belt surface. Generally, tolerances are as shown on the right-hand side.

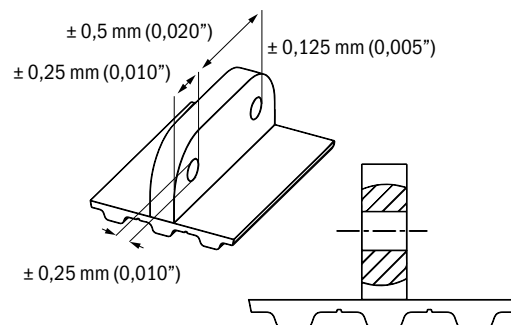



## 7. PROFILES WITH INSERTS

Profiles can be molded with metallic inserts. These are particularly useful in some applications to replace roller chains with attachments.

The actual inserts can either be manufactured by Gates or provided by the customer.

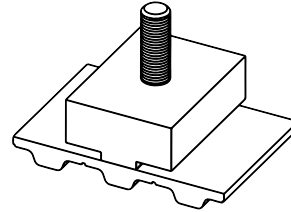

## 8. FLASH BEAD

The welding process can cause a weld bead of polyurethane between belt back and the lower profile edge. This can be removed on customer request.

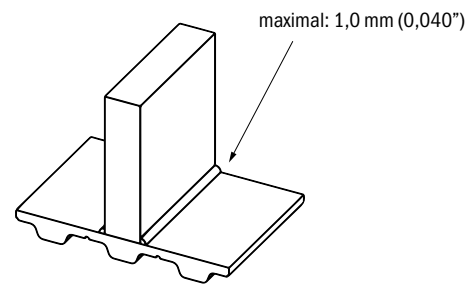

## 9. PERPENDICULARITY

All profiles are perpendicular to  $\pm 1^\circ$ .

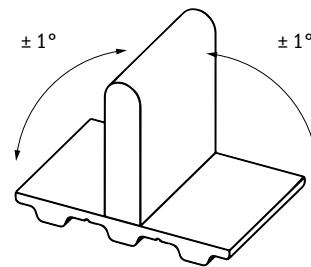

## 10. ORDERING

When ordering a profiled belt, it is advisable to submit a drawing of the profiled belt. For your convenience standard drawing forms are available from our Applications Engineering Department. Once a design is finalized, Gates will submit the drawing to the customer for approval. This custom belt drawing number should be used for future ordering.



# PROFILE SELECTOR

## OUR ONLINE PROFILE SELECTOR TOOL ALLOWS YOU TO:

- Find the right profile for your application
- Download of drawings for each selection
- Review minimum pulley recommendations
- Go to our website: [www.gates.com/tpu](http://www.gates.com/tpu)
- Chose Category/Gates TPU Polyurethane Belting/Industrial Belting
- Scroll down to Synchro-Power Industrial Beling Fabrication And Accessories
- Scroll down to Product Resources you will find The Belt Profile Selector

PLEASE CONTACT OUR APPLICATIONS ENGINEERING GROUP FOR SPECIAL PROFILE SHAPES, DIMENSIONS OR TOLERANCES.

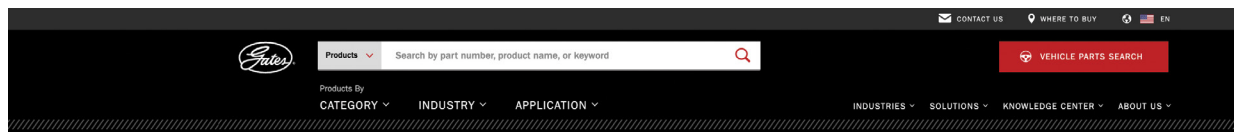

Home > Knowledge Center > Engineering Applications > Gates TPU™ Belt Profile Selector

## Gates TPU™ Belt Profile Selector

Account Number

Search By Profile Number or Keyword

► Shape

► Features

► Dimensions

► Other

250+ results

 <b>AN1001</b> TRAPEZOID FEATURES NONE LENGTH 330.2 mm    HEIGHT 12.7 mm THICKNESS 6.4 mm    WELD FOOT 6.4 mm	 <b>AN1002</b> TRAPEZOID FEATURES NONE LENGTH 330.2 mm    HEIGHT 15.9 mm THICKNESS 6.4 mm    WELD FOOT 6.4 mm	 <b>AN1003</b> OTHERS FEATURES NONE LENGTH 330.2 mm    HEIGHT 15.9 mm THICKNESS 9.5 mm    WELD FOOT 9.5 mm	 <b>AN1004</b> TRIANGLE FEATURES NONE LENGTH 330.2 mm    HEIGHT 25.4 mm THICKNESS 9.5 mm    WELD FOOT 9.5 mm	 <b>AN1005</b> OTHER RECTANGLE FEATURES NONE LENGTH 254.0 mm    HEIGHT 38.1 mm THICKNESS 6.4 mm    WELD FOOT 6.4 mm
 <b>AN1006</b> TRAPEZOID FEATURES NONE LENGTH 304.8 mm    HEIGHT 19.8 mm THICKNESS 19.1 mm    WELD FOOT 19.1 mm	 <b>AN1007</b> TRAPEZOID FEATURES NONE LENGTH 304.8 mm    HEIGHT 10.3 mm THICKNESS 19.1 mm    WELD FOOT 19.1 mm	 <b>AN1008</b> TRIANGLE FEATURES SUPPORT LEG - BACK ONLY LENGTH 304.8 mm    HEIGHT 21.6 mm THICKNESS 17.5 mm    WELD FOOT 4.8 mm	 <b>AN1009</b> OTHER RECTANGLE FEATURES NONE LENGTH 304.8 mm    HEIGHT 44.5 mm THICKNESS 28.035 mm    WELD FOOT 6.4 mm	 <b>AN1010</b> TRAPEZOID FEATURES NONE LENGTH 279.4 mm    HEIGHT 3.2 mm THICKNESS 10.1 mm    WELD FOOT 10.1 mm



# FABRICATION CAPABILITIES

Gates TPU offers further finishing for belts to achieve a variety of application requirements. From ground edges or surfaces and tight tolerances to punching or machining holes and slots and CNC machining of 3-dimensional contours, Gates TPU provides a range of customized solutions.



## MILLING:

LENGTH	500 mm up to 52.000 mm
WIDTH	10 mm up to 450 mm

## PUNCHING/CNC MACHINING:

LENGTH	500 mm up to 30.000 mm
WIDTH	10 mm up to 450 mm
MIN. HOLE DIAMETER:	1 mm
NO MAX. HOLE DIAMETER	

## GRINDING:

LENGTH	500 mm up to 50.000 mm
WIDTH	10 mm up to 250 mm

## REMOVING INDIVIDUAL TEETH

SLOTING	The flexibility can be increased by cross grooving thick coatings
---------	---

OUR APPLICATION ENGINEERS WILL HELP YOU WITH YOUR CUSTOM REQUIREMENTS.

## ADVANTAGES

- Unlimited adaptability for nearly all dimensions, contours and configurations
- Combination of flexible base belt manufacturing and additional fabrication in one hand

## EXAMPLE OF USE

- Vacuum belts for precise transportation of light weight goods such as paper sheets or films
- Conveying for automotive production applications

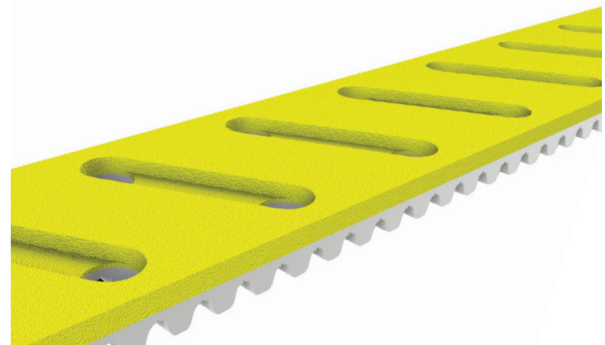
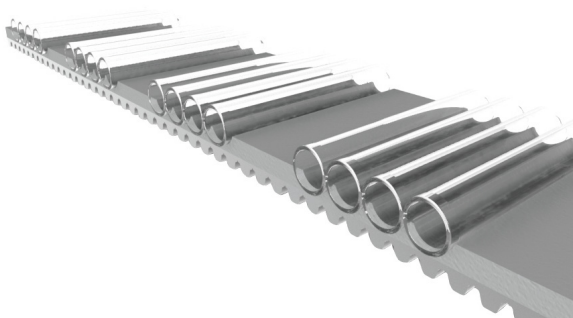
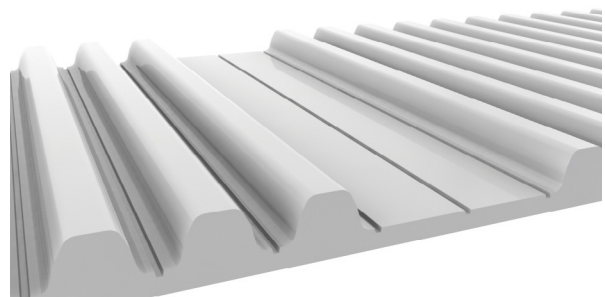
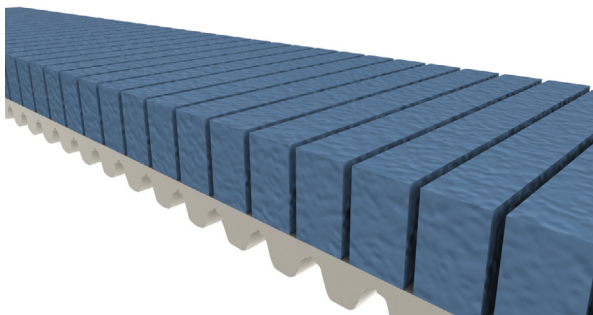
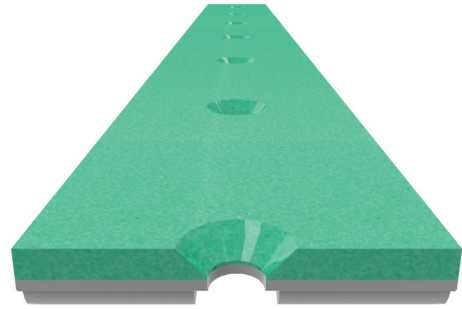
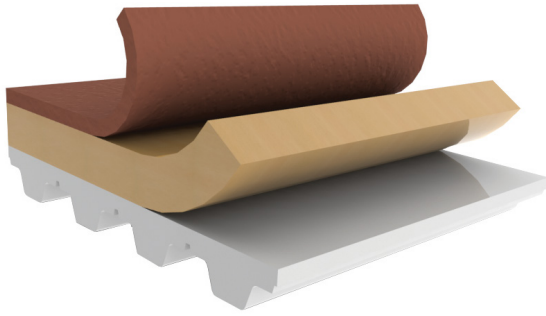



# TECHNICAL DESIGN

In order to ensure the design of proper belt drive systems, we provide technical data and equations to aid in the necessary calculations. For any questions regarding the information and/or data within this section, please contact our application engineers.

a	Acceleration [m/s <sup>2</sup> ]	l	Gauge Length during Frequency Measurement [mm]
$\beta$	Angle of Inclination [°]	L <sub>1</sub>	Tight Side Length [mm]
C <sub>R</sub>	Overall Stiffness [N]	L <sub>2</sub>	Slack Side Length [mm]
C <sub>SP</sub>	Belt Stiffness [N]	m	Mass [kg]
d	Diameter	m <sub>a</sub>	Mass of accumulated Good [kg]
$\Delta x$	Elongation [mm]	m <sub>b</sub>	Mass of Belt [kg/m]
$\Delta x_{pos}$	Positional Deviation [mm]	m <sub>c</sub>	Mass of Counter Weight [kg]
f	Frequency [Hz]	m <sub>f</sub>	Mass of Transported Goods [kg]
F <sub>1</sub>	Tight Side Belt Force [N]	$\mu$	Coefficient of Friction between Belt and Support
F <sub>1all</sub>	Allowable Belt Force [N]	$\mu_a$	Coefficient of Friction between Belt and Transported Material
F <sub>1max</sub>	Maximum occurring Belt Force [N]	n	Speed [1/min]
F <sub>2opt</sub>	Optimal Slack Side Force [N]	$\rho$	Vacuum [N/m <sup>2</sup> ]
F <sub>a</sub>	Acceleration Force [N]	P <sub>M</sub>	Motor Power on Output Shaft [kW]
F <sub>break</sub>	Breaking Force [N]	P <sub>N</sub>	Nominal Power [kW]
F <sub>e</sub>	Effective Force [N]	$d_{pulley}$	Diameter of Driver Pulley [mm]
F <sub>eall</sub>	Allowable Effective Force [N]	S <sub>iBreak</sub>	Safety Factor on Breaking Force
F <sub>eallapp</sub>	Maximum Allowable Effective Force Application [N]	S <sub>iF1</sub>	Safety Factor on allowable Belt Force
F <sub>f</sub>	Friction Force [N]	S <sub>iFe</sub>	Safety Factor on allowable Effective Force
F <sub>fa</sub>	Friction Force during Accumulation [N]	S <sub>f</sub>	Safety Factor
F <sub>fv</sub>	Friction Force due to Vacuum [N]	t <sub>m</sub>	Tooth in Mesh Factor
F <sub>g</sub>	Gravitational Force [N]	T	Torque [Nm]
F <sub>pre</sub>	Force for Pretensioning [N]	T <sub>M</sub>	Torque of Motor Output Shaft [Nm]
F <sub>w</sub>	Externally applied Working Force [N]	t <sub>v</sub>	Speed Factor
g	Gravitational Acceleration [m/s <sup>2</sup> ]	v	Speed [m/s]
L	Timing Belt Length [mm]	z <sub>m</sub>	Teeth in Mesh



## A) SAFETY FACTOR

Uniform loads do not require a safety factor. However, in the case of alternating, shock, accelerating, or decelerating loads a suitable safety factor should be considered.

LOAD	Safety Factor $S_r$
LOW ALTERNATING LOAD	1,2 - 1,5
MEDIUM ALTERNATING LOAD	1,5 - 1,8
HEAVY ALTERNATING LOAD	1,8 - 2,2

Table 1

## B) TOOTH IN MESH FACTOR $t_m$ SPEED FACTOR $t_v$

TEETH IN MESH	TEETH IN MESH FACTOR
$Z_e$	$t_m$
3	0,25
4	0,33
5	0,42
6	0,50
7	0,58
8	0,67
9	0,75
10	0,83
11	0,92
12	1,00

Table 2

SPEED [M/S]	SPEED FACTOR
$v$	$t_v$
0	1,00
0,25	0,97
0,5	0,93
0,75	0,89
1	0,86
1,5	0,82
2	0,77
2,5	0,74
3	0,71
3,5	0,68
4	0,66
4,5	0,63
5	0,61
6	0,58
7	0,56
8	0,53
9	0,51
10	0,49
11	0,47
13	0,44
15	0,42
16	0,40
18	0,38
20	0,35

Table 3

## C) BRAKING / EMERGENCY STOP

Belt type and width selection is based on the calculated effective force at the driver pulley,  $F_e$ , and the calculated tight side force (tension),  $F_1$ .  $F_e$  and  $F_1$  should be calculated for peak load conditions, such as emergency braking, as well as for normal operating conditions. The following section illustrates how  $F_e$  and  $F_1$  are calculated for various applications.

# CALCULATION OF CONVEYING APPLICATIONS

## A) CALCULATION OF EFFECTIVE FORCE $F_e$

The effective force  $F_e$  at the driver pulley is derived from the sum of all individual forces resisting the belt motion. The individual loads contributing to the effective force must be identified and calculated based on the loading conditions and drive configurations. To determine the effective force please use the method for conveying as follows:

$$F_e = \sum F_{\text{Resistance}}$$

### I. FRICTION FORCE $F_f$

The friction force between the timing belt and the slider bed due to the weight of the conveyed good that is normal (perpendicular) to the direction of conveyance.

$$F_f = \mu \times g \times m_f \times \cos\beta$$

### II. FRICTION FORCE DURING ACCUMULATION $F_{Fa}$

The friction force between the timing belt, slider bed and the conveyed material due to the mass component of the accumulated material vertically to the direction of conveyance.

$$F_{Fa} = (\mu + \mu_a) \times g \times m_a \times \cos\beta$$

### III. GRAVITATIONAL FORCE $F_G$

Force to lift the material being transported on an inclined conveyor.

$$F_G = m_f \times g \times \sin\beta$$

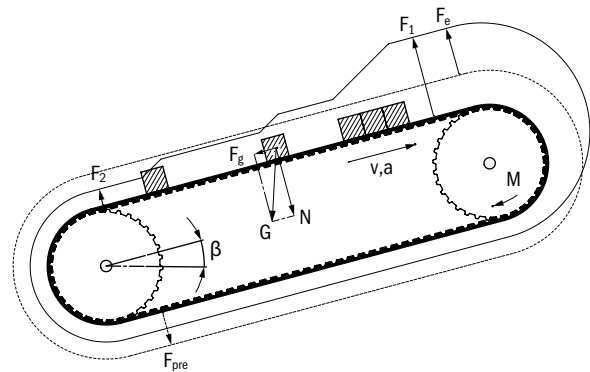

### IV. ACCELERATION FORCE $F_a$

Force to accelerate the mass of the conveyed good.

$$F_a = m_f \times a$$

### V. ADDITIONAL FORCES

Motion resistance resulting from the belt or idler mass, or other components are typically insignificant. If these additional forces are considered significant relative to the initial  $F_e$  calculated, they need to be calculated and added to  $F_e$ .

## TECHNICAL DATA - COEFFICIENT OF FRICTION

- Polyurethane vs. Steel dry 0,5 up to 0,7
- Polyurethane vs. Aluminum dry 0,5 up to 0,6
- Polyurethane vs. UHMWPE dry 0,2 up to 0,4
- Polyamide vs. Steel dry 0,2 up to 0,4
- Polyamide vs. UHMWPE dry 0,1 up to 0,3





## B) CALCULATION OF FORCE FOR PRE-TENSIONING $F_{pre}$

For trouble-free operation, it is necessary that the slack side does not fall below a certain tension. The pre-tension prevents jumping of the pulley teeth during belt operation. In order to collect the pre-tension, the optimal slack side force has to be ascertained as follows:

$$F_{2opt} = (0,1...0,3) \times F_e$$

Higher values are recommended for longer belt lengths.

Assuming an optimal slack side force, the force for pre-tensioning is calculated considering the tight side length  $L_1$  and the total timing belt length  $L$  as follows:

$$F_{pre} = F_{2opt} + F_e \times L_1/L$$

## C) CALCULATION OF TIGHT SIDE BELT FORCE $F_1$

In the worst case the tight side belt force results as follows (application moving at full load):

$$F_1 = F_e + F_{pre}$$

## D) BELT SELECTION

The selection of the belt type and width is determined by comparing the above calculated values,  $F_e$  and  $F_1$ , to our catalog values. After making an initial selection of a belt type, determine the number of teeth that are constantly engaged in the pulley. For example, a belt that is wrapped  $180^\circ$  around a pulley with 20 teeth has 10 teeth engaged in that pulley. If less than 12 teeth are engaged, the allowable effective force  $F_{eall}$  must be corrected with a tooth-in-mesh factor  $t_m$  which is found in table 2. In addition to correcting for teeth in mesh, the allowable effective force  $F_{eall}$  also needs to be corrected by applying a speed factor  $t_v$  which can be found in table 3. The result is a maximum allowable effective Force Applied as follows:

$$F_{eallapp} = F_{eall} \times t_m \times t_v$$

$F_{eallapp}$  and  $F_{1all}$  should be larger than the actual prevailing forces in the application.

$$F_{eallapp} > F_e$$

$$F_{1all} > F_1$$

## E) CALCULATION OF SAFETY FACTOR $S_f$

### I. SAFETY FACTOR ON ALLOWABLE EFFECTIVE FORCES $S_{fFe}$

$$S_{fFe} = F_{eallapp} / F_e$$

### II. SAFETY FACTOR ON ALLOWABLE BELT FORCE $S_{fF1}$

$$S_{fF1} = F_{1all} / F_1$$

### III. SAFETY FACTOR ON ULTIMATE TENSILE STRENGTH $S_{fBreak}$

$$S_{fBreak} = F_{Break} / F_1$$

Both calculated allowable safety factors  $S_{fFe}$  and  $S_{fF1}$  should be higher than required safety factor found in table 1 depending on the type of load.

# CALCULATION OF LINEAR POSITIONING APPLICATIONS

## A) CALCULATION OF EFFECTIVE FORCE $F_e$

The effective force  $F_e$  at the driver pulley is derived from the sum of all individual forces resisting the belt motion. The individual loads contributing to the effective force must be identified and calculated based on the loading conditions and drive configurations.

$$F_e = \sum F_{\text{Resistance}}$$

### I. ACCELERATION FORCE $F_a$

Force to accelerate the loaded slide with mass  $m_f$ .

$$F_a = m_f \times a$$

### II. FRICTION FORCE $F_f$

The friction force of the linear rail / bearing system.

$$F_f = \mu \times g \times m_f \times \cos\beta$$

### III. GRAVITATIONAL FORCE $F_g$

Force to lift the loaded slide with mass  $m_f$  on an inclined linear actuator.

$$F_g = m_f \times g \times \sin\beta$$

### IV. ADDITIONAL FORCES

Motion resistance resulting from the belt or idler mass, or other components are typically insignificant. If these additional forces are considered significant relative to the initial  $F_e$  calculated, they need to be calculated and added to  $F_e$ .

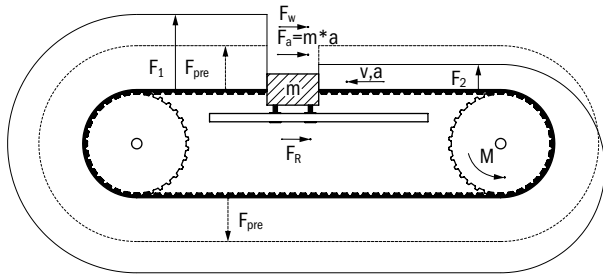

## B) CALCULATION OF FORCE FOR PRE-TENSIONING $F_{pre}$

For trouble-free operation, it is necessary that the slack side does not fall below a certain tension. The pre-tension prevents jumping of the pulley teeth during belt operation. In order to collect the pre-tension, the optimal slack side force has to be ascertained as follows:

$$F_{2opt} = (0,1...0,3) \times F_e$$

Higher values are recommended for longer belt lengths. Assuming an optimal slack side force, the force for pre-tensioning is calculated considering the tight side length  $L_1$  and the total timing belt length  $L$  as follows:

$$F_{pre} = F_{2opt} + F_e \times L_1/L$$



## C) CALCULATION OF TIGHT SIDE BELT FORCE $F_1$

In the worst case the tight side belt force results as follows (application moving at full load):

$$F_1 = F_e + F_{pre}$$

## D) BELT SELECTION

The selection of the belt type and width is determined by comparing the above calculated values,  $F_e$  and  $F_1$ , to our catalog values. After making an initial selection of a belt type, determine the number of teeth that are constantly engaged in the pulley. For example, a belt that is wrapped  $180^\circ$  around a pulley with 20 teeth has 10 teeth engaged in that pulley. If less than 12 teeth are engaged, the allowable effective force  $F_{eall}$  must be corrected with a tooth-in-mesh factor  $t_m$  which is found in table 2. In addition to correcting for teeth in mesh, the allowable effective force  $F_{eall}$  also needs to be corrected by applying a speed factor  $t_v$  which can be found in table 3. The result is a maximum allowable effective Force applied as follows:

$$F_{eallapp} = F_{eall} \times t_m \times t_v$$

$F_{eallapp}$  and  $F_{1all}$  should be larger than the actual prevailing forces in the application.

$$F_{eallapp} > F_e$$

$$F_{1all} > F_1$$

## E) CALCULATION OF SAFETY FACTOR $S_F$

I. SAFETY FACTOR ON ALLOWABLE EFFECTIVE FORCES  $S_{iFe}$   $S_{iFe} = F_{eallapp} / F_e$

II. SAFETY FACTOR ON ALLOWABLE EFFECTIVE FORCES  $S_{iF1}$   $S_{iF1} = F_{1all} / F_1$

III. SAFETY FACTOR ON ALLOWABLE EFFECTIVE FORCES  $S_{iBreak}$   $S_{iBreak} = F_{Break} / F_1$

Both calculated allowable safety factors  $S_{iFe}$  and  $S_{iF1}$  should be higher than required safety factor found in table 1 depending on the type of load.



# CALCULATION OF OMEGA LINEAR POSITIONING APPLICATIONS

## A) CALCULATION OF EFFECTIVE FORCE $F_e$

The effective force  $F_e$  at the driver pulley is derived from the sum of all individual forces resisting the belt motion. The individual loads contributing to the effective force must be identified and calculated based on the loading conditions and drive configurations.

$$F_e = \sum F_{\text{Resistance}}$$

### I. ACCELERATION FORCE $F_a$

Force to accelerate the loaded slide with mass  $m_f$ .

$$F_a = m_f \times a$$

### II. FRICTION FORCE $F_f$

The friction force of the linear rail / bearing system.

$$F_f = \mu \times g \times m_f \times \cos\beta$$

### III. GRAVITATIONAL FORCE $F_g$

Force to lift the loaded slide with mass  $m_f$  on an inclined linear actuator.

$$F_g = m_f \times g \times \sin\beta$$

### IV. ADDITIONAL FORCES

Motion resistance resulting from the belt or idler mass, or other components are typically insignificant. If these additional forces are considered significant relative to the initial  $F_e$  calculated, they need to be calculated and added to  $F_e$ .

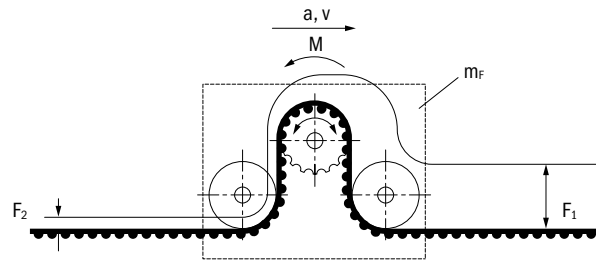

## B) CALCULATION OF FORCE FOR PRE-TENSIONING $F_{pre}$

For trouble-free operation, it is necessary that the slack side does not fall below a certain tension. The pre-tension prevents jumping of the pulley teeth during belt operation. In order to collect the pre-tension, the optimal slack side force has to be ascertained as follows:

$$F_{2opt} = (0,1...0,3) \times F_e$$

Higher values are recommended for longer belt lengths. Assuming an optimal slack side force, the force for pre-tensioning is calculated considering the tight side length  $L_1$  and the total timing belt length  $L$  as follows:

$$F_{pre} = F_{2opt} + F_e \times L_1/L$$



## C) CALCULATION OF TIGHT SIDE BELT FORCE $F_1$

In the worst case the tight side belt force results as follows (application moving at full load):

$$F_1 = F_e + F_{pre}$$

## D) BELT SELECTION

The selection of the belt type and width is determined by comparing the above calculated values,  $F_e$  and  $F_1$ , to our catalog values. After making an initial selection of a belt type, determine the number of teeth that are constantly engaged in the pulley. For example, a belt that is wrapped  $180^\circ$  around a pulley with 20 teeth has 10 teeth engaged in that pulley. If less than 12 teeth are engaged, the allowable effective force  $F_{eall}$  must be corrected with a tooth-in-mesh factor  $t_m$  which is found in table 2. In addition to correcting for teeth in mesh, the allowable effective force  $F_{eall}$  also needs to be corrected by applying a speed factor  $t_v$  which can be found in table 3. The result is a maximum allowable effective Force applied as follows:

$$F_{eallapp} = F_{eall} \times t_m \times t_v$$

$F_{eallapp}$  and  $F_{1all}$  should be larger than the actual prevailing forces in the application.

$$F_{eallapp} > F_e$$

$$F_{1all} > F_1$$

## E) CALCULATION OF SAFETY FACTOR $S_F$

I. SAFETY FACTOR ON ALLOWABLE EFFECTIVE FORCES  $S_{F_{Fe}}$   $S_{F_{Fe}} = F_{eallapp} / F_e$

II. SAFETY FACTOR ON ALLOWABLE EFFECTIVE FORCES  $S_{F_1}$   $S_{F_1} = F_{1all} / F_1$

III. SAFETY FACTOR ON ALLOWABLE EFFECTIVE FORCES  $S_{F_{Break}}$   $S_{F_{Break}} = F_{Break} / F_1$

Both calculated allowable safety factors  $S_{F_{Fe}}$  and  $S_{F_1}$  should be higher than required safety factor found in table 1 depending on the type of load.



# CALCULATION OF LIFTING APPLICATIONS: TWO PULLEYS NO COUNTER WEIGHT

## A) CALCULATION OF EFFECTIVE FORCE $F_e$

The effective force  $F_e$  at the driver pulley is derived from the sum of all individual forces resisting the belt motion. The individual loads contributing to the effective force must be identified and calculated based on the loading conditions and drive configuration.

$$F_e = \sum F_{\text{Resistance}}$$

### I. GRAVITATIONAL FORCE $F_g$

Force to lift the loaded slide with mass  $m$ .

$$F_g = m \times g$$

### II. ACCELERATION FORCE $F_a$

Force to accelerate the loaded slide with mass  $m$ .

$$F_a = m \times a$$

### III. ADDITIONAL FORCES

An estimate of the frictional forces that resist the belt motion should be added to the sum of the above calculated forces to determine the effective force  $F_e$ . Motion resistance resulting from the belt or idler mass, or other components are typically insignificant. If these additional forces are considered significant relative to the initial  $F_e$  calculated, they need to be calculated and added to  $F_e$ .

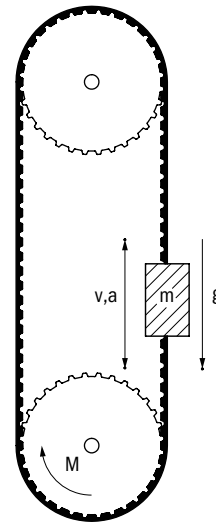

## B) CALCULATION OF FORCE FOR PRE-TENSIONING $F_{pre}$

For trouble-free operation, it is necessary that the slack side does not fall below a certain tension. The pre-tension prevents jumping of the pulley teeth during belt operation. In order to collect the pre-tension, the optimal slack side force has to be ascertained as follows:

$$F_{2opt} = (0,1 \dots 0,3) \times F_e$$

Higher values are recommended for longer belt lengths. Assuming an optimal slack side force, the force for pre-tensioning is calculated considering the tight side length  $L_1$  and the total timing belt length  $L$  as follows:

$$F_{pre} = F_{2opt} + F_e \times L_1/L$$



## C) CALCULATION OF TIGHT SIDE BELT FORCE $F_1$

In the worst case the tight side belt force results as follows (Conveyor moving at full load):

$$F_1 = F_e + F_{pre}$$

## D) BELT SELECTION

The selection of the belt type and width is determined by comparing the above calculated values,  $F_e$  and  $F_1$ , to our catalog values. After making an initial selection of a belt type, determine the number of teeth that are constantly engaged in the pulley. For example, a belt that is wrapped  $180^\circ$  around a pulley with 20 teeth has 10 teeth engaged in that pulley. If less than 12 teeth are engaged, the allowable effective force  $F_{eall}$  must be corrected with a tooth-in-mesh factor  $t_m$  which is found in table 2. In addition to correcting for teeth in mesh, the allowable effective force  $F_{eall}$  also needs to be corrected by applying a speed factor  $t_v$  which can be found in table 3. The result is a maximum allowable effective Force Applied as follows:

$$F_{eallapp} = F_{eall} \times t_m \times t_v$$

$F_{eallapp}$  and  $F_{1all}$  should be larger than the actual prevailing forces in the application.

$$F_{eallapp} > F_e$$

$$F_{1all} > F_1$$

## E) CALCULATION OF SAFETY FACTOR $S_f$

I. SAFETY FACTOR ON ALLOWABLE EFFECTIVE FORCE  $S_{iFe}$   $S_{iFe} = F_{eallapp} / F_e$

II. SAFETY FACTOR ON ALLOWABLE BELT FORCE  $S_{iF1}$   $S_{iF1} = F_{1all} / F_1$

III. SAFETY FACTOR ON ULTIMATE TENSILE STRENGTH  $S_{iBreak}$   $S_{iBreak} = F_{Break} / F_1$

Both calculated allowable safety factors  $S_{iFe}$  and  $S_{iF1}$  should be higher than required safety factor found in table 1 depending on the type of load.

# CALCULATION OF LIFTING APPLICATIONS: TWO PULLEYS WITH COUNTER WEIGHT

## A) CALCULATION OF EFFECTIVE FORCE $F_e$

The effective force  $F_e$  at the driver pulley is derived from the sum of all individual forces resisting the belt motion. The individual loads contributing to the effective force must be identified and calculated based on the loading conditions and drive configuration.

$$F_e = \sum F_{\text{Resistance}}$$

### I. ACCELERATION FORCE $F_a$

Force to accelerate the loaded slide with mass  $m$ .

$$F_a = m \times (g + a) - m_c \times (g - a)$$

### II. ADDITIONAL FORCES

An estimate of the frictional forces that resist the belt motion should be added to the sum of the above calculated forces to determine the effective force  $F_e$ . Motion resistance resulting from the belt or idler mass, or other components are typically insignificant. If these additional forces are considered significant relative to the initial  $F_e$  calculated, they need to be calculated and added to  $F_e$ .

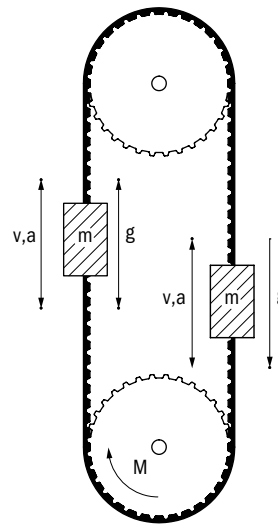

## B) CALCULATION OF FORCE FOR PRE-TENSIONING $F_{pre}$

For trouble-free operation, it is necessary that the slack side does not fall below a certain tension. The pre-tension prevents jumping of the pulley teeth during belt operation. In order to collect the pre-tension, the optimal slack side force has to be ascertained as follows:

$$F_{2opt} = (0,1...0,3) \times F_e$$

Higher values are recommended for longer belt lengths. Assuming an optimal slack side force, the force for pre-tensioning is calculated considering the tight side length  $L_1$  and the total timing belt length  $L$  as follows:

$$F_{pre} = F_{2opt} + F_e \times L_1/L$$





## C) CALCULATION OF TIGHT SIDE BELT FORCE $F_1$

In the worst case the tight side belt force results as follows (lifter moving at full load):

$$F_1 = F_a + F_{pre} + F_f$$

## D) BELT SELECTION

The selection of the belt type and width is determined by comparing the above calculated values,  $F_e$  and  $F_1$ , to our catalog values. After making an initial selection of a belt type, determine the number of teeth that are constantly engaged in the pulley. For example, a belt that is wrapped  $180^\circ$  around a pulley with 20 teeth has 10 teeth engaged in that pulley. If less than 12 teeth are engaged, the allowable effective force  $F_{eall}$  must be corrected with a tooth-in-mesh factor  $t_m$  which is found in table 2. In addition to correcting for teeth in mesh, the allowable effective force  $F_{eall}$  also needs to be corrected by applying a speed factor  $t_v$  which can be found in table 3. The result is a maximum allowable effective Force Applied as follows:

$$F_{eallapp} = F_{eall} \times t_m \times t_v$$

$F_{eallapp}$  and  $F_{1all}$  should be larger than the actual prevailing forces in the application.

$$F_{eallapp} > F_e$$

$$F_{1all} > F_1$$

## E) CALCULATION OF SAFETY FACTOR $S_f$

### I. SAFETY FACTOR ON ALLOWABLE EFFECTIVE FORCE $S_{iFe}$

$$S_{iFe} = F_{eallapp} / F_e$$

### II. SAFETY FACTOR ON ALLOWABLE BELT FORCE $S_{iF1}$

$$S_{iF1} = F_{1all} / F_1$$

### III. SAFETY FACTOR ON ULTIMATE TENSILE STRENGTH $S_{iBreak}$

$$S_{iBreak} = F_{Break} / F_1$$

Both calculated allowable safety factors  $S_{iFe}$  and  $S_{iF1}$  should be higher than required safety factor found in table 1 depending on the type of load.

# CALCULATION OF LIFTING APPLICATIONS: ONE PULLEY WITH COUNTER WEIGHT

## A) CALCULATION OF EFFECTIVE FORCE $F_e$

The effective force  $F_e$  at the driver pulley is derived from the sum of all individual forces resisting the belt motion. The individual loads contributing to the effective force must be identified and calculated based on the loading conditions and drive configuration.

$$F_e = \sum F_{\text{Resistance}}$$

### I. ACCELERATION FORCE $F_a$

Force to accelerate the loaded slide with mass  $m$ .

$$F_a = m \times (g + a) - m_c \times (g - a)$$

### II. FRICTION FORCE $F_f$

The friction force of the linear rail / bearing system.

### III. ADDITIONAL FORCES

Motion resistance on the basis of belt mass, idler or similar are normally insignificant, but may have a decisive influence on the total value of the effective force and therewith on the belt load as well. The importance of mentioned influences has to be estimated throughout the calculations – in extreme cases the component forces must be calculated and considered.

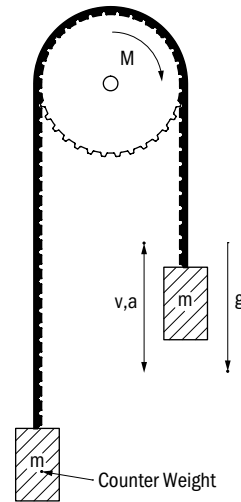

## B) CALCULATION OF FORCE FOR PRE-TENSIONING $F_{\text{pre}}$

Not available for lifting applications with counter weight and one pulley.

## C) CALCULATION ON TIGHT SIDE BELT FORCE $F_1$

In the worst case the light side belt force results as follows (conveyor moving at full load):

$$F_1 = F_a + F_f$$



## D) BELT SELECTION

The selection of the belt type and width is determined by comparing the above calculated values,  $F_e$  and  $F_1$ , to our catalog values. After making an initial selection of a belt type, determine the number of teeth that are constantly engaged in the pulley. For example, a belt that is wrapped  $180^\circ$  around a pulley with 20 teeth has 10 teeth engaged in that pulley. If less than 12 teeth are engaged, the allowable effective force  $F_{eall}$  must be corrected with a tooth-in-mesh factor  $t_m$  which is found in table 2. In addition to correcting for teeth in mesh, the allowable effective force  $F_{eall}$  also needs to be corrected by applying a speed factor  $t_v$  which can be found in table 3. The result is a maximum allowable effective Force Applied as follows:

$$F_{eallapp} = F_{eall} \times t_m \times t_v$$

$F_{eallapp}$  and  $F_{1all}$  should be larger than the actual prevailing forces in the application.

$$F_{eallapp} > F_e$$

$$F_{1all} > F_1$$

## E) CALCULATION OF SAFETY FACTOR $S_f$

I. SAFETY FACTOR ON ALLOWABLE EFFECTIVE FORCE  $S_{iFe}$   $S_{iFe} = F_{eallapp} / F_e$

II. SAFETY FACTOR ON ALLOWABLE BELT FORCE  $S_{iF1}$   $S_{iF1} = F_{1all} / F_1$

III. SAFETY FACTOR ON ULTIMATE TENSILE STRENGTH  $S_{iBreak}$   $S_{iBreak} = F_{Break} / F_1$

Both calculated allowable safety factors  $S_{iFe}$  and  $S_{iF1}$  should be higher than required safety factor found in table 1 depending on the type of load.

# CALCULATION OF CLOSED BELT APPLICATIONS

Power transmission drives should always be designed with truly endless Synchro-Power Belts or Synchro-Power Flex belts.

The use of endless welded timing belts is not recommended.

## A) CALCULATION OF NOMINAL POWER

The nominal Power is used for the calculation of the required belt width

$$P_N = P_M \times S_f \quad S_f \text{ is found in table 1}$$

## B) CALCULATION OF EFFECTIVE FORCE $F_e$

The effective force  $F_e$  can be calculated with the existing movement resistance as follows:

$$F_e = \sum F_{\text{Resistance}}$$

Furthermore the effective force can also be calculated with the existing driving power as follows:

$$F_e = S_f \times (T_M \times 2000) / d$$

or

$$F_e = S_f \times (19100 \times P_N \times 1000) / n \times d$$

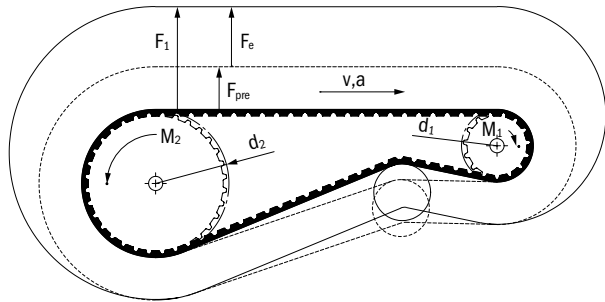

## B) CALCULATION OF FORCE FOR PRE-TENSIONING $F_{pre}$

For trouble-free operation, it is necessary that the slack side does not fall below a certain tension. The pre-tension prevents jumping of the pulley teeth during belt operation. In order to collect the pre-tension, the optimal slack side force has to be ascertained as follows:

$$F_{2opt} = (0,1 \dots 0,3) \times F_e$$

Higher values are recommended for longer belt lengths. Assuming an optimal slack side force, the force for pre-tensioning is calculated considering the tight side length  $L_1$  and the total timing belt length  $L$  as follows:

$$F_{pre} = F_{2opt} + F_e \times L_1 / L$$

## C) CALCULATION ON TIGHT SIDE BELT FORCE $F_1$

In the worst case the tight side belt force  $F_1$  results as follows (application moving at full load):

$$F_1 = F_e + F_{pre}$$



## D) BELT SELECTION

The selection of the belt type and width is determined by comparing the above calculated values,  $F_e$  and  $F_1$ , to our catalog values. After making an initial selection of a belt type, determine the number of teeth that are constantly engaged in the pulley. For example, a belt that is wrapped  $180^\circ$  around a pulley with 20 teeth has 10 teeth engaged in that pulley. If less than 12 teeth are engaged, the allowable effective force  $F_{eall}$  must be corrected with a tooth-in-mesh factor  $t_m$  which is found in table 2. In addition to correcting for teeth in mesh, the allowable effective force  $F_{eall}$  also needs to be corrected by applying a speed factor  $t_v$  which can be found in table 3. The result is a maximum allowable effective Force Applied as follows:

$$F_{eallapp} = F_{eall} \times t_m \times t_v$$

$F_{eallapp}$  and  $F_{1all}$  should be larger than the actual prevailing forces in the application.

$$F_{eallapp} > F_e$$

$$F_{1all} > F_1$$

## E) CALCULATION OF SAFETY FACTOR $S_f$

I. SAFETY FACTOR ON ALLOWABLE EFFECTIVE FORCE  $S_{iFe}$   $S_{iFe} = F_{eallapp} / F_e$

II. SAFETY FACTOR ON ALLOWABLE BELT FORCE  $S_{iF1}$   $S_{iF1} = F_{1all} / F_1$

III. SAFETY FACTOR ON ULTIMATE TENSILE STRENGTH  $S_{iBreak}$   $S_{iBreak} = F_{Break} / F_1$

Both calculated allowable safety factors  $S_{iFe}$  and  $S_{iF1}$  should be higher than required safety factor found in table 1 depending on the type of load.



## 9. ELONGATION / POSITIONING ERROR IN TIMING BELT DRIVES

### A) ELONGATION $\Delta x$

The static elongation based on an applied force such as the pre-tension results as follows:

$$\Delta x = F \times L / C_{sp}$$

### B) POSITIONING ERROR $\Delta x_{Pos}$

The positioning error mainly depends on the total stiffness  $C_R$  of the slack and tight side.

$$C_R = C_{sp} \times L / (L_1 \times L_2)$$

Note that  $C_R$  is at its minimum when the tight and slack sides are equal.

Determine the positioning error  $\Delta x_{Pos}$  due to belt elongation caused by e.g. the effective force  $F_e$ :

$$\Delta x_{Pos} = F / C_R$$

## 10. TIMING BELT INSTALLATION

### A) PRETENSION

For proper adjustment of pre-tensioning  $F_{pre}$  Gates recommends the Sonic Tension Meter 508 C which directly specifies the pre-tension in Newton.

Alternatively with the tension meter you may measure the belt frequency of the sonic wave that is generated by vibrating the belt span of the stationary belt.

The desired frequency can be calculated as follows:

$$f = \sqrt{\frac{F_{pre} \times 10^6}{4 \times m_b \times l^2}}$$

### B) PRETENSION INSTALLATION RECOMMENDATION

Please refer to the Gates Sonic Tension Meter Manual.

The timing belt should be first installed without any tension. Apply the calculated pre-tension to the belt by using the tensioning device. When measuring the belt tension, turn the drive over for several revolutions to fully seat the belt into the pulleys and equalize tension in all of the spans. Repeat the tension measurements at different pulley positions. After applying the pretension, lock all adjustable shafts into place.

# SONIC TENSION METER

**MOD. 308C**  
**PRODUCT #7420-00100**

Our selection of time-saving tools are a technician's best friend and a facility manager's trusted companion. Gates professional tools offer simple solutions for quick onsite and equipment inspection, maintenance and repairs, backed by the Gates guarantee of world-class quality and reliable long-term performance.





The specifications listed are based on Gates experience. However, our specifications and data do NOT cover all possible belts drive conditions. It is the responsibility of the belt drive system designer to ensure Gates belts are appropriate for a given system and application. The provided data is representative of our in-house experience and does not necessarily match product performance in industrial use. Gates cannot assume any liability concerning the suitability and process ability of our products. We also cannot assume liability for process results, damage or consequential damages associated with the use of our products.

Do not use Gates belts in applications that depend solely upon the belt to raise/lower, support or sustain a mass without an independent safety backup system. Gates products are not suitable for applications in aircraft.

ALL INFORMATION CONTAINED ARE SUBJECT TO CHANGE WITH OUT NOTICE.





**DRIVEN BY POSSIBILITY™**

GATES TPU GMBH  
WERNER VON SIEMENS STRASSE 2  
64319 PFUNGSTADT, GERMANY  
TEL. +49 (0) 6157-9727-0  
EMAIL: SALES-PFUNGSTADT@GATES.COM

---

THE MANUFACTURERS RESERVE THE RIGHT TO AMEND DETAILS WHERE NECESSARY.  
E2/20166 - ©GATES - PRINTED IN BELGIUM - 2022.

**GATES.COM/TPU**